



Ex II 3G Ex ec IIC T4 Gc
Ex II 3D Ex tc IIIB T125°C Dc



IO-Link



Modbus

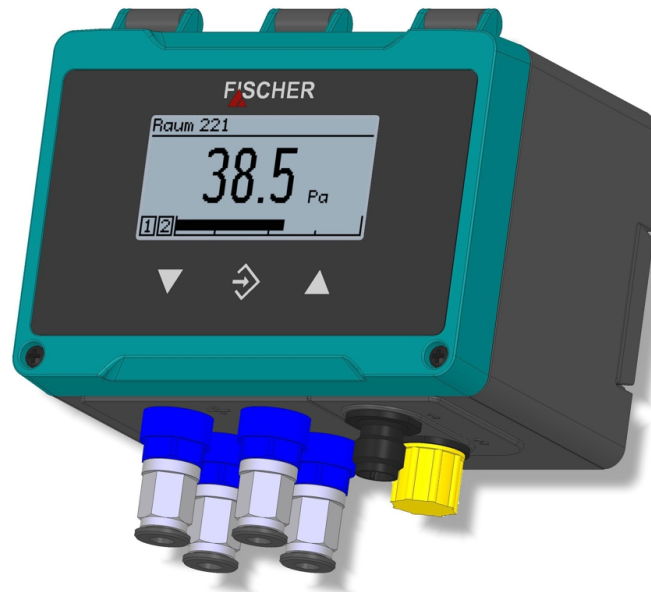

Operating manual

DE91

Differential pressure transmitter
PRO-LINE®

for low pressure measurements

09015444 • BA_EN_DE91 • Rev. ST4-B • 07/24

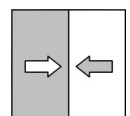

Masthead

Manufacturer:**FISCHER Mess- und Regeltechnik GmbH**Bielefelderstr. 37a
D-32107 Bad SalzuflenTelephone: +49 5222 974 0
Telefax: +49 5222 7170eMail: info@fischermesstechnik.deweb: www.fischermesstechnik.de**Technical editorial team:**

Documentation representative: T. Malischewski

Technical editor: R. Kleemann

All rights, also those to the translation, reserved. No part of this document may be reproduced or processed, duplicated or distributed using electronic systems or any other form (print, photocopy, microfilm or another process) without the written consent of the company FISCHER Mess- und Regeltechnik GmbH, Bad Salzuflen.

Reproduction for internal use is expressly allowed.

Brand names and procedures are used for information purposes only and do not take the respective patent situation into account. Great care was taken when compiling the texts and illustrations; Nevertheless, errors cannot be ruled out. The company FISCHER Mess- und Regeltechnik GmbH will not accept any legal responsibility or liability for this.

Subject to technical amendments.



© FISCHER Mess- und Regeltechnik 2024

Version history

Rev. ST4-A 04/24	Version 1 (first edition)
Rev. ST4-B 07/24	Version 2 (correction structure and mode of action)

Table of contents

1 Safety instructions	7
1.1 General	7
1.2 Personnel Qualification	7
1.3 Risks due to Non-Observance of Safety Instructions	7
1.4 Safety Instructions for the Operating Company and the Operator	7
1.5 Unauthorised Modification	7
1.6 Inadmissible Modes of Operation	7
1.7 Safe working practices for maintenance and installation work	8
1.8 Pictogram explanation	8
2 Product and functional description	10
2.1 Delivery scope	10
2.2 Intended use	10
2.2.1 Explosion hazard area classification	10
2.2.1.1 Gas explosion protection	10
2.2.1.2 Dust explosion protection	10
2.3 Function diagram	11
2.4 Design and mode of operation	11
2.4.1 Equipment	12
2.4.2 Modbus RTU	12
2.4.3 IO-Link	12
2.5 Equipment versions	13
2.5.1 Type plate	15
3 Installation	16
3.1 General	16
3.2 Mounting in explosive areas	16
3.3 Process connection	17
3.3.1 Replacement plates	17
3.3.2 Cutting ring screw connections	18
3.4 Electrical connections	19
3.4.1 Operation in areas at risk of explosion	19
3.4.2 Devices only with switching outputs	20
3.4.2.1 Circuit	20
3.4.2.2 M12 connector 1: auxiliary energy	21
3.4.2.3 M12 connector 2: switch outputs	21
3.4.3 Devices with switching and analog outputs	22
3.4.3.1 Circuit	22
3.4.3.2 M12 connector 1: auxiliary energy and analogue output	23
3.4.3.3 M12 connector 2: switch outputs	23
3.4.4 Devices with Modbus (without switch outputs)	24
3.4.4.1 Connection to an existing Modbus RTU network	24
3.4.4.2 Auxiliary energy supply	25
3.4.4.3 M12 connector 1: Modbus IN	26
3.4.4.4 M12 connector 2: Modbus OUT	26

3.4.5	Devices with Modbus (and 4 switch outputs).....	27
3.4.5.1	Connection to an existing Modbus RTU network.....	27
3.4.5.2	Auxiliary energy supply.....	28
3.4.5.3	M12 connector 1: Modbus.....	29
3.4.5.4	M12 connector 2: Switch outputs.....	29
3.4.6	Devices with IO-Link.....	30
3.4.6.1	M12 connector 1: IO-Link.....	30
3.4.6.2	M12 connector 2: Switch outputs.....	30
3.4.7	USB port.....	31
4	Start-up.....	32
4.1	Installation control.....	32
4.2	Switch on the measuring device.....	32
4.2.1	Measured value display.....	32
4.2.1.1	1 channel version.....	33
4.2.1.2	2 channel version.....	33
4.2.1.3	3 channel version.....	34
4.2.1.4	Back lighting.....	34
4.2.2	Keyboard.....	35
4.3	Setup.....	36
4.3.1	Set menu language.....	36
4.3.2	Measuring point designation.....	36
4.3.3	Configuration.....	36
4.4	Modbus RTU interface.....	36
4.5	IO-Link Interface.....	36
5	Operation.....	37
5.1	First steps.....	37
5.1.1	Passwords.....	37
5.1.2	Operating modes.....	37
5.1.3	Menu tree.....	38
5.1.4	Navigation in the menu tree.....	41
5.1.5	Path details.....	43
5.1.6	Input.....	43
5.1.6.1	Text input.....	43
5.1.6.2	Value input.....	44
5.1.6.3	Selection of options.....	46
5.2	Main menu.....	47
5.3	Login.....	48
5.3.1	Log in / log out.....	49
5.3.2	Timeout.....	50
5.3.3	Manage users.....	50
5.3.3.1	User 1.....	51
5.3.3.1.1	User 1 permissions.....	51
5.3.3.2	Administrator.....	52
5.3.4	Reset passwords.....	53
5.4	Configuration.....	54
5.4.1	Channel 1.....	56
5.4.1.1	Mode C1.....	57

5.4.1.2	Measurement C1	58
5.4.1.2.1	Measuring range C1 unit.....	59
5.4.1.2.2	Measuring range C1 start.....	59
5.4.1.2.3	Measuring range C1 end.....	60
5.4.1.2.4	Damping C1	60
5.4.1.2.5	Offset C1	61
5.4.1.2.6	Zero-point window C1	61
5.4.1.2.7	Limits.....	62
5.4.1.3	Characteristic curve C1 (menu expansion).....	63
5.4.1.3.1	Characteristic C1 (flow rate).....	63
5.4.1.3.2	Characteristic C1 (Table)	64
5.4.1.3.3	Characteristic C1 (volume flow)	66
5.4.1.3.4	Characteristic C1 (linear function)	69
5.4.1.4	Number format C1	70
5.4.1.5	Colour change C1.....	71
5.4.1.5.1	Colour change C1 type: red/green	72
5.4.1.5.2	Colour-change C1 type: red/yellow/green.....	73
5.4.1.5.3	Colour change C1 hysteresis	74
5.4.1.5.4	Colour change C1 delay on.....	76
5.4.1.5.5	Colour change C1 delay off.....	76
5.4.2	Channel 2.....	77
5.4.3	Channel 3.....	77
5.4.3.1	Mode C3	78
5.4.3.2	Measurement C3	79
5.4.3.2.1	Formula C3	80
5.4.3.3	Characteristic C3 (menu expansion)	81
5.4.3.3.1	Characteristic C3 (+flow rate).....	81
5.4.3.3.2	Characteristic C3 (+table)	82
5.4.3.3.3	Characteristic C3 (dynamic filter monitoring)	83
5.4.3.4	Number format C3	89
5.4.3.5	Colour change C3.....	90
5.4.4	Analog output.....	91
5.4.4.1	Analog output 1 type.....	92
5.4.4.2	Analog output 1 assignment	92
5.4.4.3	Signal limits.....	93
5.4.5	Switch output	94
5.4.5.1	SP1 assignment.....	95
5.4.5.2	SP1 function	95
5.4.5.3	Switching function.....	96
5.4.6	Display	97
5.4.6.1	Language.....	98
5.4.6.2	Designation.....	98
5.4.6.3	Measuring data display.....	98
5.4.6.4	Colour change assignment.....	99
5.4.6.5	LCD colour.....	100
5.4.6.6	LCD lighting	100
5.4.6.7	LCD contrast.....	101
5.4.7	Modbus RTU.....	102
5.4.7.1	Baud rate	103
5.4.7.2	Data format.....	103
5.4.7.3	Modbus address	104
5.4.7.4	Byte order	104

5.5	Info	105
5.6	Service	106
5.6.1	Firmware update	107
6	Servicing	108
6.1	Maintenance	108
6.2	Transport	108
6.3	Service	108
6.4	Disposal.....	108
7	Technical data	109
7.1	General.....	109
7.2	Input variables	109
7.2.1	Sensor type A (capacitive)	110
7.2.2	Sensor type B (piezoresistive)	111
7.3	Output sizes	112
7.4	Measuring accuracy	113
7.4.1	Sensor type A (capacitive)	113
7.4.2	Sensor type B (piezoresistive)	114
7.5	Digital interfaces	114
7.6	Auxiliary energy	115
7.7	Operating conditions	115
7.8	Display.....	115
7.9	Construction design.....	115
7.9.1	Materials	116
7.9.2	Dimensional drawings.....	117
8	Order codes	119
8.1	Accessories	122
9	Attachments	124
9.1	EU Declaration of Conformity	124
9.2	UKCA declaration of conformity	126
9.3	EAC Declaration of conformity	128

1 Safety instructions

1.1 General

This operating manual contains basic instructions for the installation, operation and maintenance of the device that must be followed without fail. It must be read by the installer, the operator and the responsible specialist personnel before installing and commissioning the device.

This operating manual is an integral part of the product and therefore needs to be kept close to the instrument in a place that is accessible at all times to the responsible personnel.

The following sections, in particular instructions about the assembly, commissioning and maintenance, contain important information, non-observance of which could pose a threat to humans, animals, the environment and property.

The instrument described in these operating instructions is designed and manufactured in line with the state of the art and good engineering practice.

1.2 Personnel Qualification

The instrument may only be installed and commissioned by specialized personnel familiar with the installation, commissioning and operation of this product.

Specialized personnel are persons who can assess the work they have been assigned and recognize potential dangers by virtue of their specialized training, their skills and experience and their knowledge of the pertinent standards.

1.3 Risks due to Non-Observance of Safety Instructions

Non-observance of these safety instructions, the intended use of the device or the limit values given in the technical specifications can be hazardous or cause harm to persons, the environment or the plant itself.

The supplier of the equipment will not be liable for damage claims if this should happen.

1.4 Safety Instructions for the Operating Company and the Operator

The safety instructions governing correct operation of the instrument must be observed. The operating company must make them available to the installation, maintenance, inspection and operating personnel.

Dangers arising from electrical components, energy discharged by the medium, escaping medium and incorrect installation of the device must be eliminated. See the information in the applicable national and international regulations.

Please observe the information about certification and approvals in the Technical Data section.

1.5 Unauthorised Modification

Modifications of or other technical alterations to the instrument by the customer are not permitted. This also applies to replacement parts. Only the manufacturer is authorised to make any modifications or changes.

1.6 Inadmissible Modes of Operation

The operational safety of this instrument can only be guaranteed if it is used as intended. The instrument model must be suitable for the medium used in the system. The limit values given in the technical data may not be exceeded.

The manufacturer is not liable for damage resulting from improper or incorrect use.

1.7 Safe working practices for maintenance and installation work

The safety instructions given in this operating manual, any nationally applicable regulations on accident prevention and any of the operating company's internal work, operating and safety guidelines must be observed.

The operating company is responsible for ensuring that all required maintenance, inspection and installation work is carried out by qualified specialized personnel.

1.8 Pictogram explanation



DANGER

Type and source of danger

This indicates a **direct** dangerous situation that could lead to death or **serious injury** (highest danger level).

1. Avoid danger by observing the valid safety regulations.



WARNING

Type and source of danger

This indicates a **potentially** dangerous situation that could lead to death or **serious injury** (medium danger level).

1. Avoid danger by observing the valid safety regulations.



CAUTION

Type and source of danger

This indicates a **potentially** dangerous situation that could lead to slight or serious injury, damage or **environmental pollution** (low danger level).

1. Avoid danger by observing the valid safety regulations.



NOTICE

Note / advice

This indicates useful information of advice for efficient and smooth operation.

Other symbols

This table explains how the different objects (menu, parameters, etc.) are shown in these operating instructions.













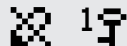

Symbol	Description
	This symbol indicates that the switch output contact is open.
	This symbol indicates that the switch output contact is closed.
<code>Meas.data display</code>	This presentation is selected for parameter or menu names.
	This symbol indicates that the administrator is still logged in.
	This symbol indicates that one of the users is still logged in. The number corresponds to the number of the user.
	This symbol indicates that user 1 only has one set of read rights. The respective user number (see above) is used for another user. There is no symbol for writing/read rights.
	This symbol indicates that there is a submenu
	This symbol indicates that there is a blocked submenu or parameter.
	This symbol is an indicator for the menu output at the next highest level.
	This symbol stands for an option that was not selected in a list.
	This symbol stands for a selected option from a list.
	This symbol stands for an activated property.
	This symbol stands for a deactivated property.
	This symbol stands for a short press of a button
	This symbol stands for a permanent push of a button hereinafter call 'repeat' or 'button repeat'.
	The guide stands for a collection of links that indicate the path to certain topics.

Table 1: Pictogram explanation

2 Product and functional description

2.1 Delivery scope

- Differential pressure transmitter DE91 PRO-LINE® version as stated on the type plate with an integrated assembly rail. Attachment screws are not included in the delivery.
- Operating Manual

2.2 Intended use

The DE91 is a configurable differential pressure transmitter with optional outputs and digital interfaces. It is suitable for measuring very low overpressure, underpressure and differential pressures in neutral gaseous media.

The device may only be used for the purpose stipulated by the manufacturer. The manufacturer will not be liable for damage arising from incorrect or improper use.

2.2.1 Explosion hazard area classification

Eurasian Economic Union (EAC):

The device does not have ATEX approval for this market. It may only be used there as an industrial device.

2.2.1.1 Gas explosion protection

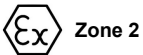

Zone 2

Devices with the order code DE91 ## ## ## # # # 000 R1 # # are suitable as "Electrical equipment for use in potentially explosive areas", Zone 2 - Gases and vapours.

Designation as per Directive 2014/34/EU:

II 3G Ex ec IIC T4 Gc

2.2.1.2 Dust explosion protection



Zone 22

Devices with the order code DE91 ## ## ## # # # 000 R1 # # are suitable as "Electrical equipment for use in areas with combustible dust", Zone 22 - dry dusts.

Designation as per Directive 2014/34/EU:

II 3D Ex tc IIIB T125°C Dc

$-20^{\circ}\text{C} \leq T_{\text{amb}} \leq 60^{\circ}\text{C}$

2.3 Function diagram

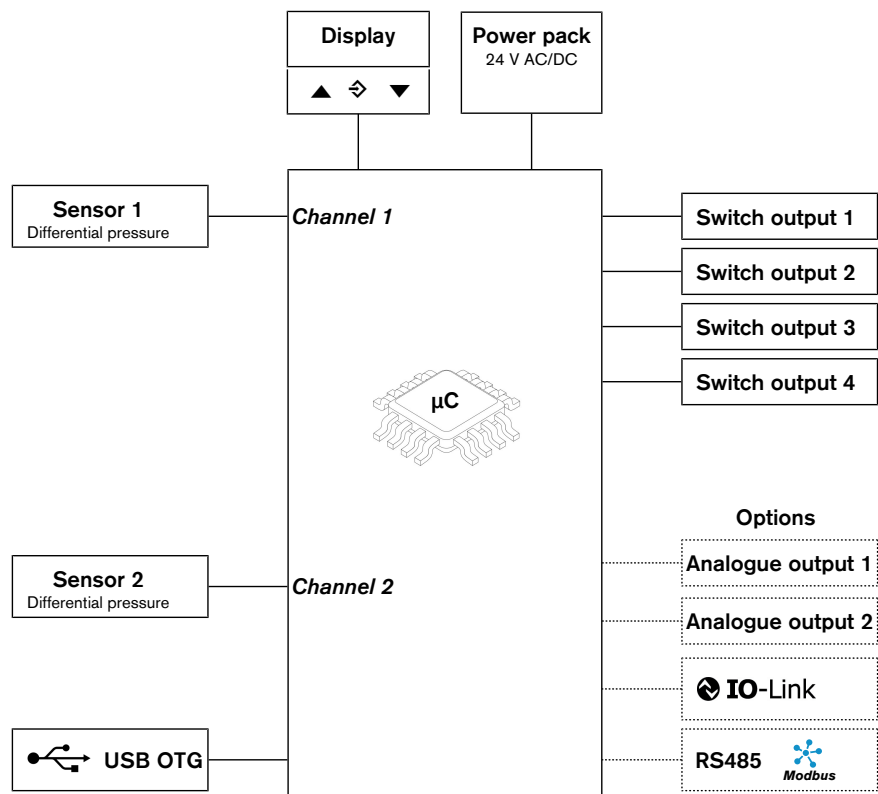

Fig. 1: Function diagram

2.4 Design and mode of operation

Depending on the measuring range and the channel used, two different sensor technologies are used. Both sensor types are equally suitable for overpressure, underpressure and differential pressure measurements.

Sensor type A is a capacitive sensor element. The pressures to be measured act directly on the sensor element with a micromechanically manufactured differential capacitor in silicon glass technology.

This type of sensor is used for channels 1 and 2.

Sensor type B is a piezoresistive sensor element. The pressures to be measured act directly on a silicon diaphragm fitted with a resistance measuring bridge.

This sensor type is only used for channel 2

Mode of action:

When the pressure is equal, the measuring diaphragm is at rest. If a pressure difference occurs, the diaphragm is deflected, resulting in a change in resistance or capacitance, depending on the sensor type. This change is analysed and displayed by the electronics integrated in the device and converted into up to four switching contacts.

Options:

The device can be equipped with up to two analogue outputs. The output signal can be attenuated, spread, inverted and also transformed non-linearly via a table function.

The device can either be equipped with a Modbus RTU interface or alternatively with an IO-Link interface.

2.4.1 Equipment

Overall, the device can be delivered with the following equipment.

Sensor type	Channel 1	Channel 2
capacitive	A	A
piezoresistiv		B

Output	1-channel	2-channel	Modbus RTU ⁾		IO-Link
			(Opt1)	(Opt2)	
Switch output 1	x	x	x	x	x
Switch output 2	x	x	x	x	x
Switch output 3		x	x	x	x
Switch output 4		x	x	x	x
Analogue output 1	x	x			
Analogue output 2		x			

Interfaces	1-channel	2-channel	Modbus RTU ⁾		IO-Link
			(Opt1)	(Opt2)	
USB interface	x	x	x	x	x
RS485 Modbus RTU			x	x	
IO-Link					x

⁾ Opt1: without switching outputs; Opt2: with switching outputs

2.4.2 Modbus RTU

For operating a device with a Modbus RTU interface, the corresponding Modbus manual is available for download from the FISCHER website.

2.4.3 IO-Link

For operating a device with an IO-Link interface, the IODD file and the corresponding interface description are available for download from the FISCHER website.

2.5 Equipment versions

Process connections

The connections presented here are used for all models.

Model:

1-channel

2-channel

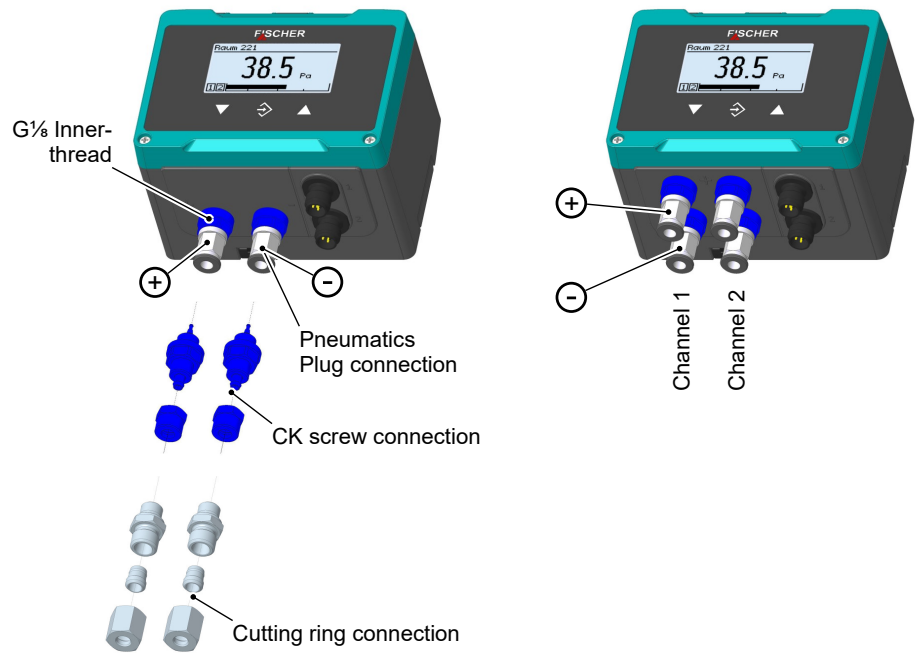

G $\frac{1}{8}$ female thread

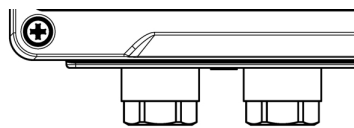

CK screw connection

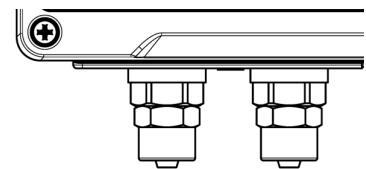

Cutting ring screw connection

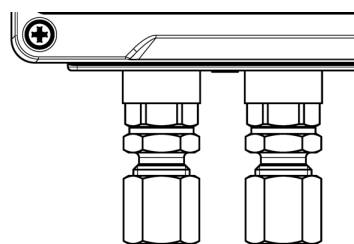

Pneumatic plug-in connector

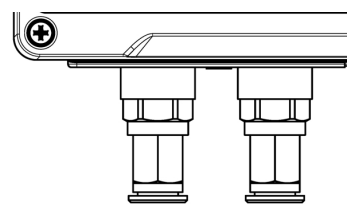
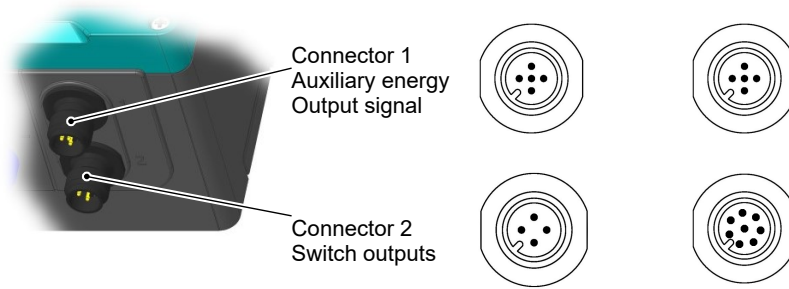

Fig. 2: Process connections

Electric connections

Two M12 flange connectors is installed for the electrical connection.

Model: Standard 1-channel 2-channel



Modbus without switch outputs

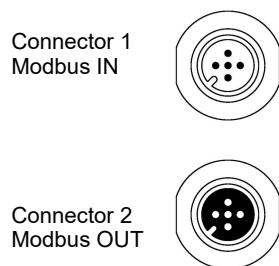

Modbus with switch outputs

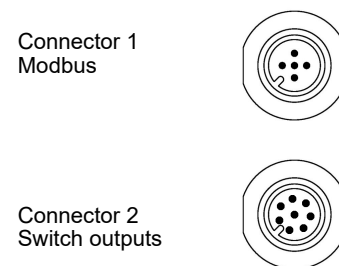

IO-Link with switch outputs

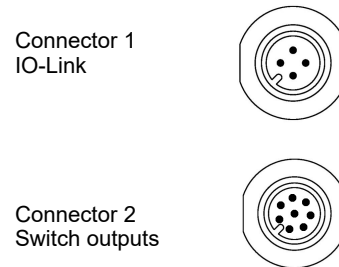

Fig. 3: Electric connections

ATEX model



Fig. 4: ATEX model

2.5.1 Type plate

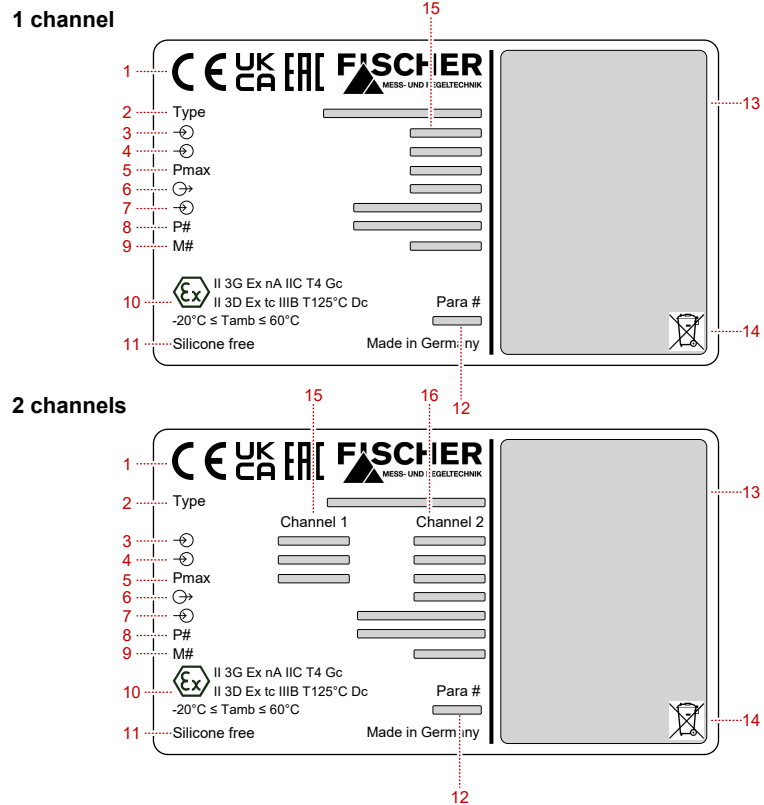



Fig. 5: Type plate

1	Conformity	2	Device type (order code)
3	Basic measuring range	4	Set measuring range
5	Overload capacity	6	Output signal
7	Auxiliary energy	8	Production number
9	Customer item number	10	ATEX marking
11	Special properties	12	Parameter number
13	Circuit diagram	14	WEEE marking
15	Data for channel 1	16	Data for channel 2

Explanations of the symbols

-  Input
-  Output
- CAL** Factory Setting
- Pmax** Proof Pressure
- P#** Production No.
- M#** Customers Art.no.
- Para. #** Parameter No.

3 Installation

3.1 General

The device is designed for installation onto assembly plates or flat walls. To this end, a pre-mounted 35 mm plastic mounting rail is also supplied. The attachment screws are not included in the delivery.

Alternatively, the device can also be mounted to a 35mm hat rail.

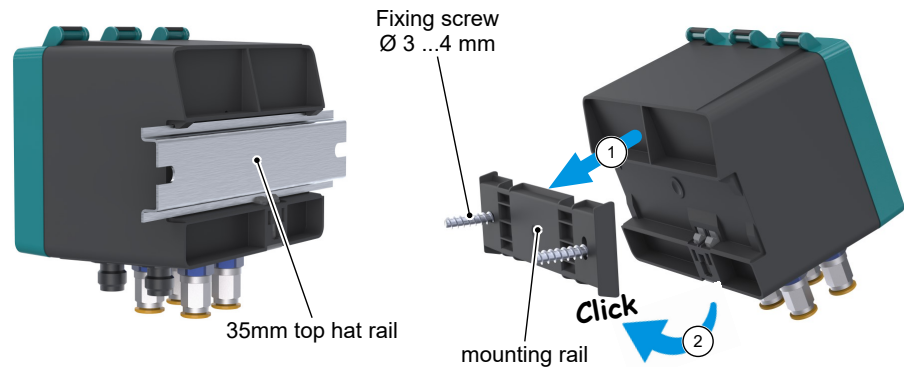

Fig. 6: Assembly

At the factory, the device is calibrated for vertical installation, but the installation position is arbitrary. For any installation positions that are not vertical, the zero-point signal can be corrected via the installed offset correction.

The enclosure protection type IP 65 is only guaranteed, if a suitable power supply cable is used (see accessories).

3.2 Mounting in explosive areas

- If operated in explosive areas, the valid local regulations and guidelines for the installation and operation of electrical systems in explosive areas must be observed.
- If units are used in potentially explosive areas, the personnel must receive additional training or briefings or have a permit to work on explosion-protected units in potentially explosive systems.

DANGER! The operator must ensure that any falling objects cannot collide with the installed unit.

Steps must be taken to prevent the impact creating sparks so that the protection class of the casing is no longer guaranteed. This can be avoided by attaching protective cover, a protective housing or similar.

3.3 Process connection

- By authorized and qualified specialized personnel only.
- The pipes need to be depressurized when the instrument is being connected.
- Appropriate steps must be taken to protect the device from pressure surges.
- Check that the device is suitable for the medium being measured.
- Maximum pressures must be observed (cf. Tech. data)

The pressure lines must be kept as short as possible and installed without any tight bends to avoid delays.

The pressure lines must be installed at an inclination so that no water pockets are created. If the required gradient is not reached, water filters need to be installed at suitable points.

The process connections are marked with (+) and (-) symbols on the device. The pressure lines must be mounted according to these symbols.

1. Differential pressure measurement

- ⊕ Higher pressure
- ⊖ lower pressure

2. Pressure measurement

- ⊕ Pressure
- ⊖ open

3.3.1 Replacement plates

Depending on the number of measuring channels, the device is equipped with various replacement plates.

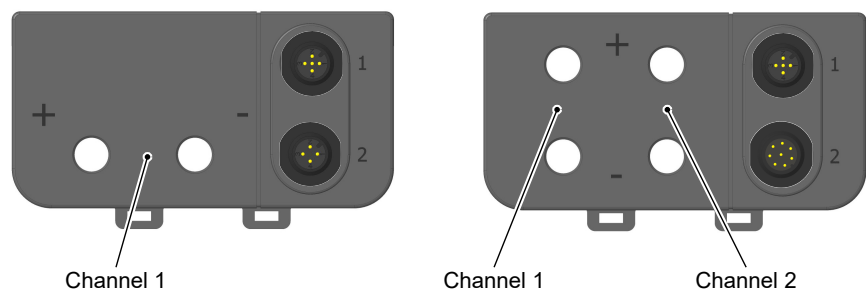

Fig. 7: Replacement plate

These replacement plates are equipped ex-works with the required process connections and the M12 flange connectors for the electrical connection. The user may not make any independent modifications.



Process connection type		size	
	Pneumatic plug connection for hydraulic hoses	Polyamide hose	6 x 4 x 1 mm 8 x 6 x 1 mm
	CK quick-action screw connection for soft hoses	PVC hose TYGON®	6 x 4 x 1 mm 8 x 6 x 1 mm
	cutting ring screw connection for hydraulic tubes (stainless steel)	tube	6 mm outside 8 mm outside

Fig. 8: Process connection table

3.3.2 Cutting ring screw connections

- ▷ In the case of cutting ring screw connections, incorrect installation of the pressure lines can lead to a destruction of the replacement plate due to the acting forces.
- ▷ The cutting ring screw connection may not be mounted to the device in one work step.
 1. Mount the cutting ring using a pre-assembly connecting piece.
 2. Always use a conventional assembly paste ⁽¹⁾ to avoid cold welding of the stainless steel parts.
 3. Carry out the final assembly work on the device with just one counter-hold. Mount the cutting ring screw connection with a quarter or half-turn of the union nut.

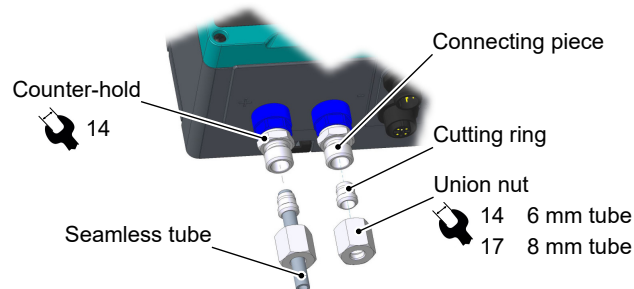

Fig. 9: Counter-hold for cutting ring screw connections

⁽¹⁾ The assembly past is not part of the delivery scope nor is it a part of the accessories.

3.4 Electrical connections

- By authorized and qualified specialized personnel only.
- When connecting the unit, the national and international electro-technical regulations must be observed.
- Disconnect the system from the mains, before electrically connecting the device.
- Install the consumer-adapted fuses.
- Do not connect the connector if strained.

3.4.1 Operation in areas at risk of explosion



⚠ WARNING

Do not connect the connector if strained

Sparks can be created, the plug is mounted under tension or replaced.

- If operated in explosive areas, the electrical data of the unit and the valid local regulations and guidelines for the installation and operation of electrical systems in explosive areas must be observed (e.g. DIN EN 60079).
- If units are used in potentially explosive areas, the personnel must receive additional training or briefings or have a permit to work on explosion-protected units in potentially explosive systems.
- A CE-conform mains adapter with a slow 200 mA fuse only may be used in the power supply circuit.

NOTICE! The outer ground connection must always be connected to the protective potential equalisation or a similar local potential equalisation.

The ground terminal is suitable for connecting fine-wire conductors up to 4 mm² or single-wire conductors up to 6 mm².

The earthing connection serves to discharge static electricity.

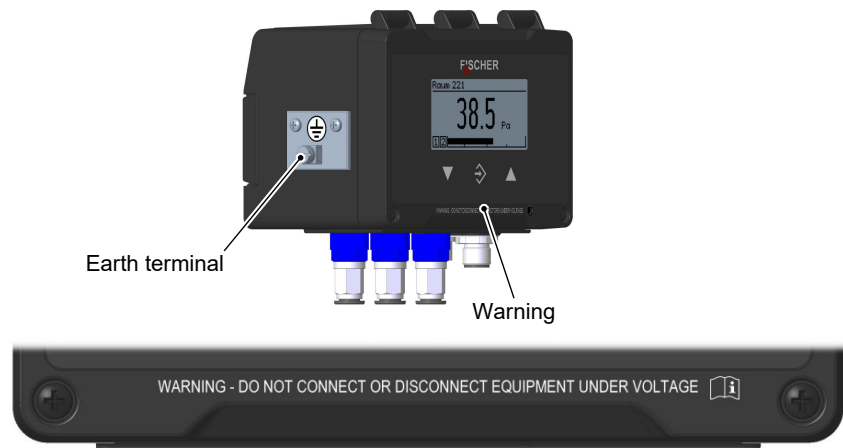

WARNING - DO NOT CONNECT OR DISCONNECT EQUIPMENT UNDER VOLTAGE

Fig. 10: Ground connection

3.4.2 Devices only with switching outputs

3.4.2.1 Circuit

The device is connected as described below. The admissible load/impedance is stated in the technical data. The connection is performed using a prefabricated sensor connection cable (see the accessories). Alternatively, a prefabricated M12 connector can be used.

NOTICE! The protection class of the housing can be guaranteed only if an IP65 connecting plug is used.

1 channel version

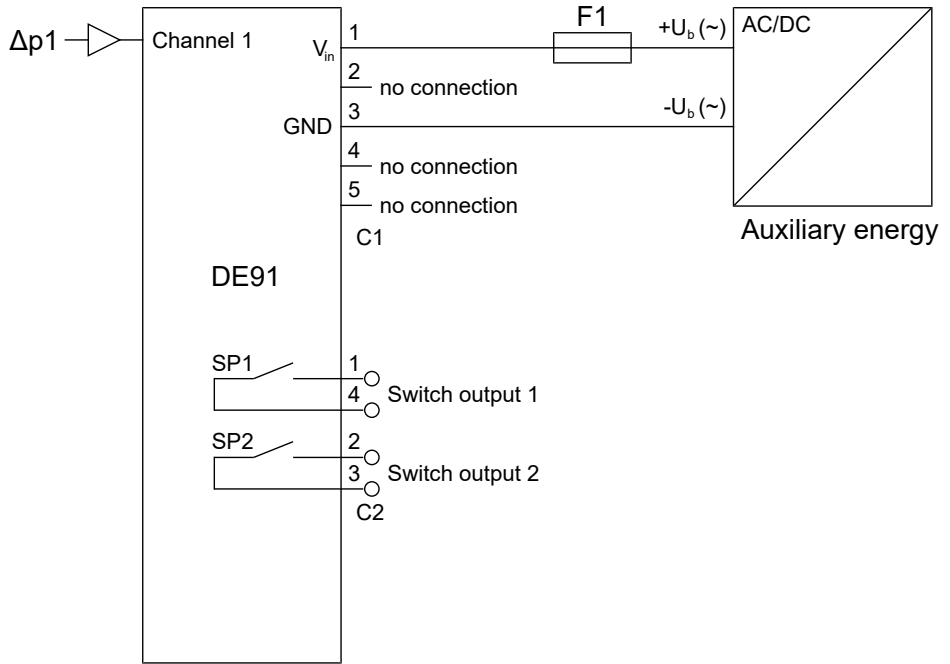

Fig. 11: 1-channel version (without analogue output)

2-channel version

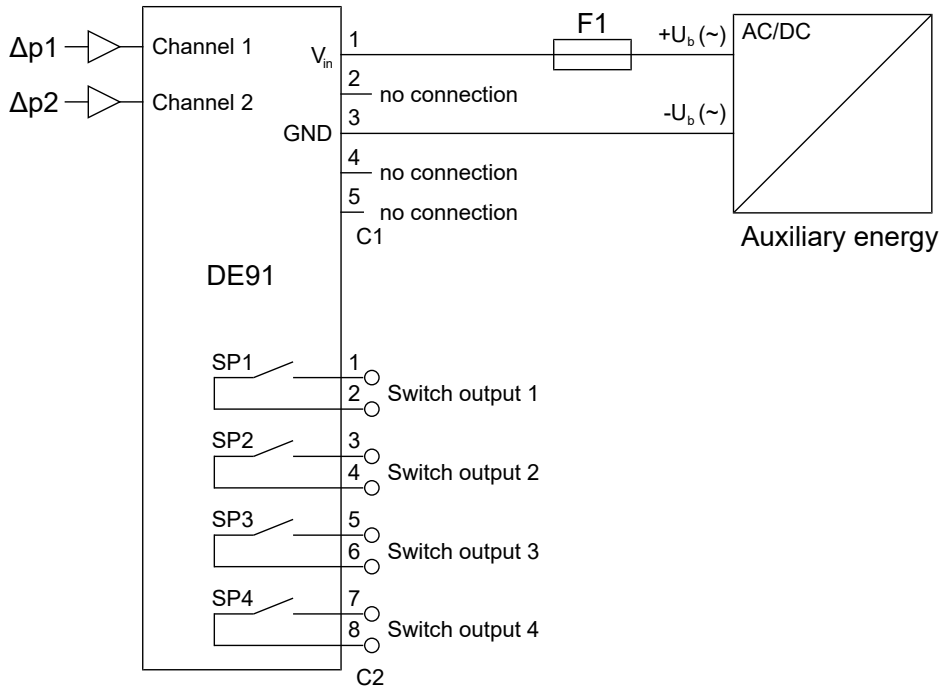

Fig. 12: 2-channel version (without analogue output)

3.4.2.2 M12 connector 1: auxiliary energy

1 channel version

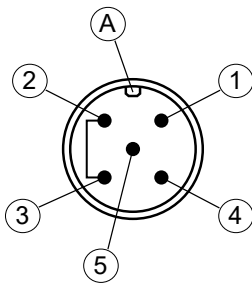

Fig. 13: M12 plug 5pin + bridge

Pin	Signal		Cable colour
1	Operating voltage	+ U _b	Brown
2	Unused		White
3	Operating voltage	- U _b	Blue
4	Unused		Black
5	Unused		Grey
A	Coding		

2 channel version

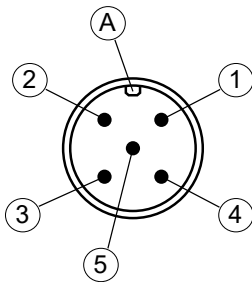

Fig. 14: M12 plug 5pin

Pin	Signal		Cable colour
1	Operating voltage	+ U _b	Brown
2	Unused		White
3	Operating voltage	- U _b	Blue
4	Unused		Black
5	Unused		Grey
A	Coding		

3.4.2.3 M12 connector 2: switch outputs

The number of switch outputs depends on the number of measuring ducts.

1 channel version

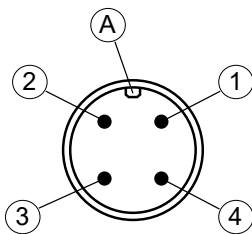

Fig. 15: M12 plug 4-pin

2 switch outputs

PIN	Signal		Cable colour
1	Switch output 1	SP1	Brown
2	Switch output 2	SP2	White
3	Switch output 2	SP2	Blue
4	Switch output 1	SP1	Black
A	Coding		

2 channel version

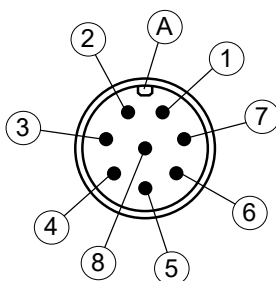

Fig. 16: M12 plug 8-pin

4 switch outputs

PIN	Signal		Cable colour
1	Switch output 1	SP1	White
2	Switch output 1	SP1	Brown
3	Switch output 2	SP2	Green
4	Switch output 2	SP2	Yellow
5	Switch output 3	SP3	Grey
6	Switch output 3	SP3	Pink
7	Switch output 4	SP4	Blue
8	Switch output 4	SP4	Red
A	Coding		

3.4.3 Devices with switching and analog outputs

3.4.3.1 Circuit

The device is connected in a 3-wire circuit as described below. The admissible load/impedance is stated in the technical data. The connection is performed using a prefabricated sensor connection cable (see the accessories). Alternatively, a prefabricated M12 connector can be used.

NOTICE! The protection class of the housing can be guaranteed only if an IP65 connecting plug is used.

1 channel version

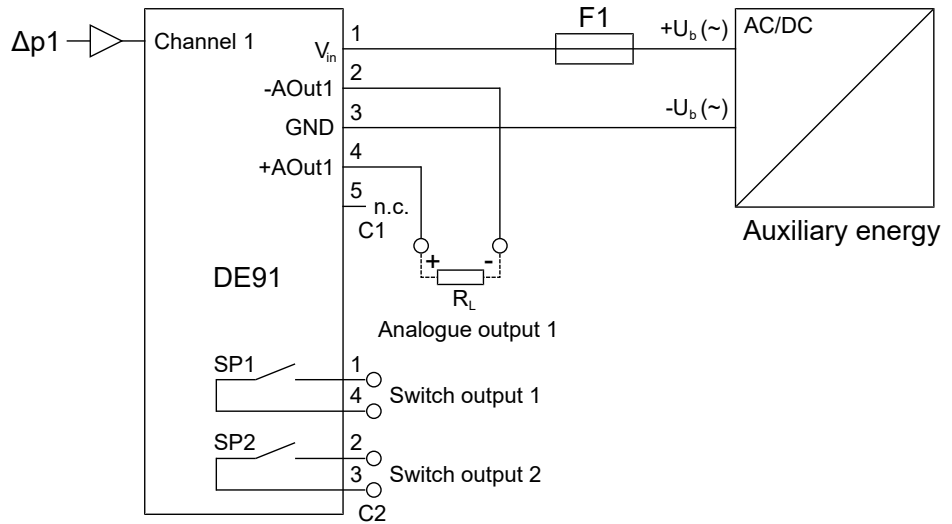

Fig. 17: 1-channel version (with analogue output)

2-channel version

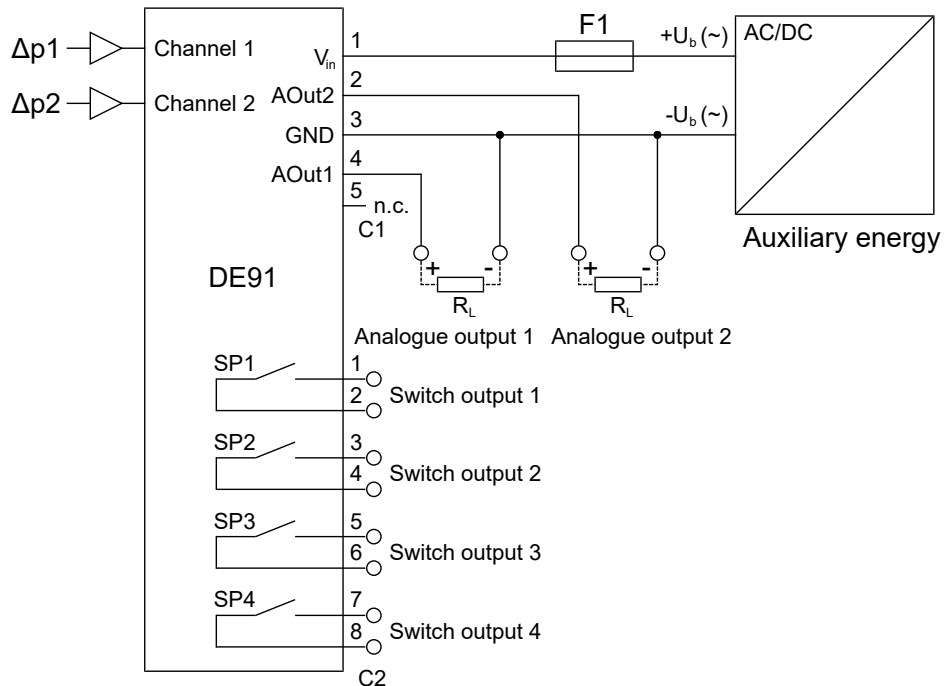

Fig. 18: 2-channel version (with analogue output)

3.4.3.2 M12 connector 1: auxiliary energy and analogue output

1 channel version

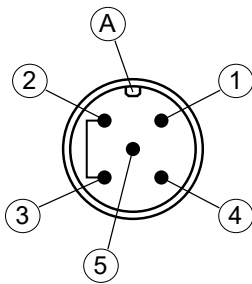

Fig. 19: M12 plug 5-pin+bridge

PIN	Signal		Cable colour
1	Operating voltage	+U _b	Brown
2	Analog output 1	-AOut1	White
3	Operating voltage	- U _b	Blue
4	Analog output 1	+AOut1	Black
5	Unused		Grey
A	Coding		

2 channel version

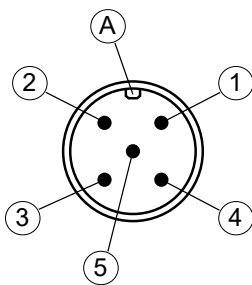

Fig. 20: M12 plug 5-pin

PIN	Signal		Cable colour
1	Operating voltage	+U _b	Brown
2	Analog output 2	AOut2	White
3	Operating voltage	- U _b	Blue
4	Analog output 1	AOut1	Black
5	Unused		Grey
A	Coding		

3.4.3.3 M12 connector 2: switch outputs

The number of switch outputs depends on the number of measuring ducts.

1 channel version

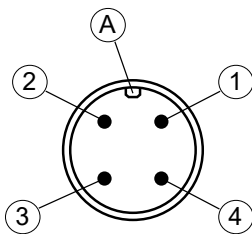

Fig. 21: M12 plug 4-pin

2 switch outputs

PIN	Signal		Cable colour
1	Switch output 1	SP1	Brown
2	Switch output 2	SP2	White
3	Switch output 2	SP2	Blue
4	Switch output 1	SP1	Black
A	Coding		

2 channel version

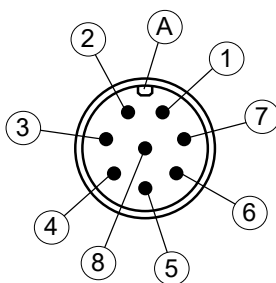

Fig. 22: M12 plug 8-pin

4 switch outputs

PIN	Signal		Cable colour
1	Switch output 1	SP1	White
2	Switch output 1	SP1	Brown
3	Switch output 2	SP2	Green
4	Switch output 2	SP2	Yellow
5	Switch output 3	SP3	Grey
6	Switch output 3	SP3	Pink
7	Switch output 4	SP4	Blue
8	Switch output 4	SP4	Red
A	Coding		

3.4.4 Devices with Modbus (without switch outputs)



⚠ DANGER

Auxiliary energy for ATEX devices

When selecting the power supply, bear in mind that it may be a potential ignition source.

Take suitable safety precautions to prevent this risk.

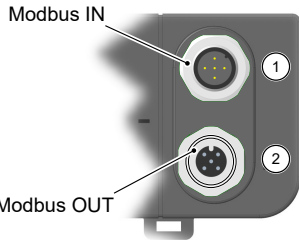

Fig. 23: Modbus replacement plate

Devices with a Modbus interface do not have analogue and switching outputs. The replacement plate is equipped with a 5-pin M12 flange connector for the Modbus input and a 5-pin M12 flange socket for the Modbus output.

The DE91 can be connected to a Modbus RTU network as a so-called slave. Up to 247 devices can be addressed in one line network.

NOTICE! Star-shaped networks are not allowed.

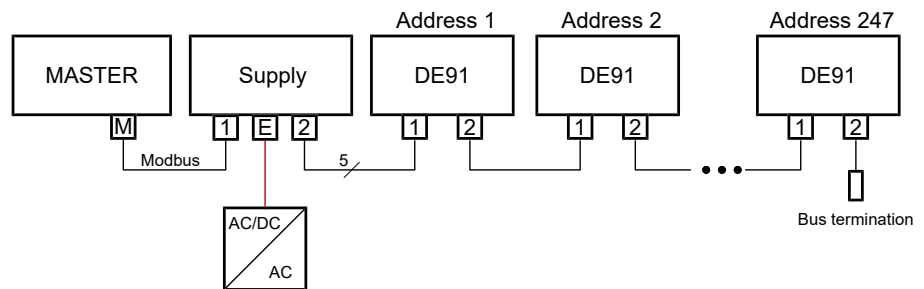

Fig. 24: Modbus RTU network

Communication takes place solely with the Modbus master. The connected slaves only react to direct commands from the master, so communication between the slaves is not possible.

To guarantee fault-free data transmission, we recommend terminating the end point of the Modbus RTU network with a 120 Ω resistor. This bus termination resistor is available as an accessory.

3.4.4.1 Connection to an existing Modbus RTU network

It can be connected to an existing Modbus network via a conventional T-piece (passive TAP).

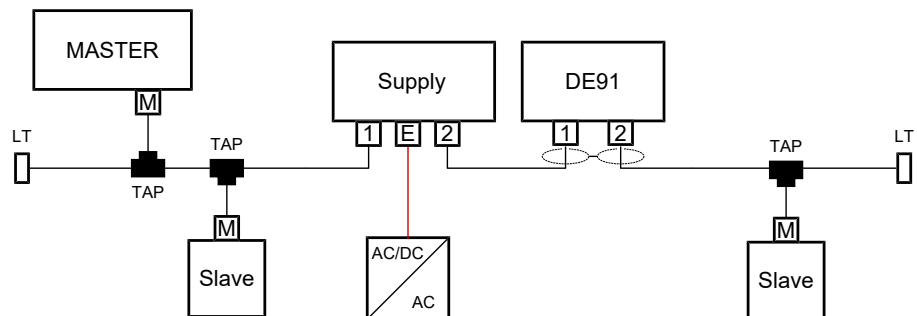

Fig. 25: Modbus connection

3.4.4.2 Auxiliary energy supply

The following illustrations explain the principle of the power supply of the DE91 in the Modbus network. However the feeder nodes are not part of the delivery scope and need to be installed by the operator.

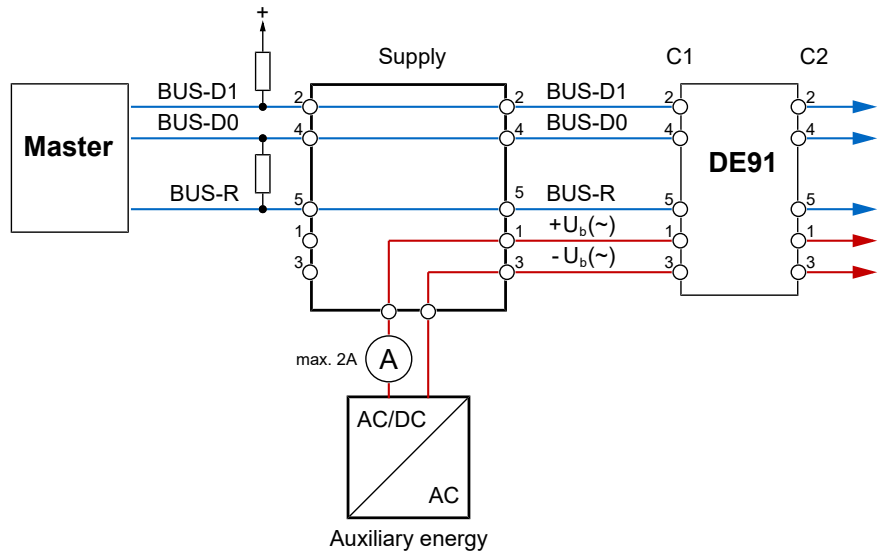

Fig. 26: Main supply

Please note that the M12 connectors are approved for max. 2A. This value may already be exceeded if there are more than 12 devices of type DE91. In this case, an intermediate auxiliary energy feed should be provided at a suitable place.

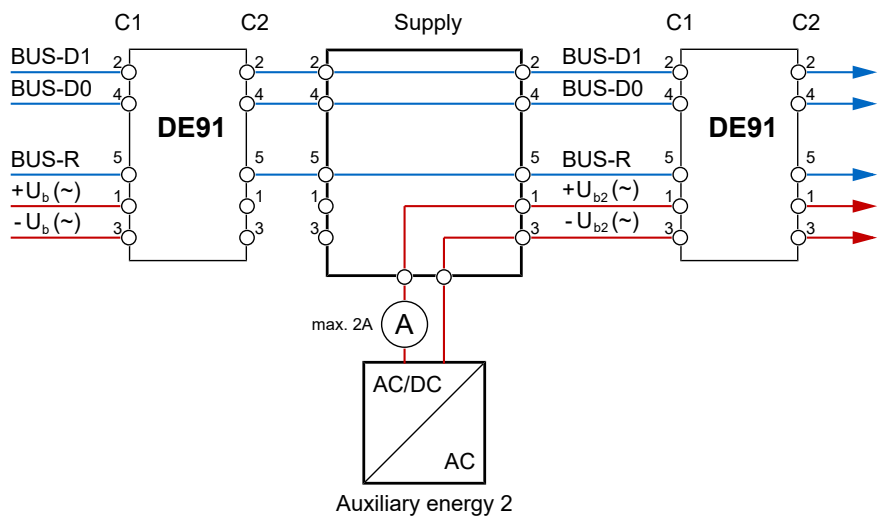

Fig. 27: Intermediate supply

3.4.4.3 M12 connector 1: Modbus IN

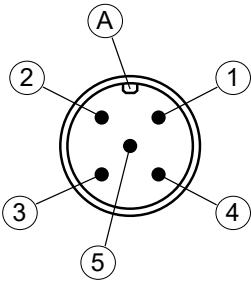

Fig. 28: M12 plug 5-pin

PIN	Signal		Cable colour
1	Operating voltage	+U _b	Brown
2	Modbus	BUS-D1	White
3	Operating voltage	- U _b	Blue
4	Modbus	BUS-D0	Black
5	Modbus	BUS-R	Grey
A	Coding		

3.4.4.4 M12 connector 2: Modbus OUT

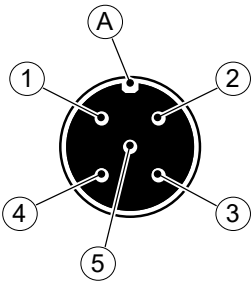

Fig. 29: M12 bush 5-pin

PIN	Signal		Cable colour
1	Operating voltage	+U _b	Brown
2	Modbus	BUS-D1	White
3	Operating voltage	- U _b	Blue
4	Modbus	BUS-D0	Black
5	Modbus	BUS-R	Grey
A	Coding		

3.4.5 Devices with Modbus (and 4 switch outputs)



⚠ DANGER

Auxiliary energy for ATEX devices

When selecting the power supply, bear in mind that it may be a potential ignition source.

Take suitable safety precautions to prevent this risk.

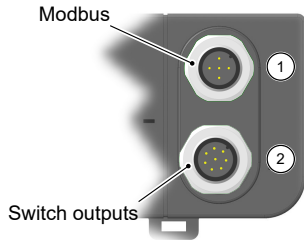

Fig. 30: Replacement plate Modbus with switch outputs

This version with a Modbus interface has 4 switch outputs. The replacement plate is equipped with a 5-pin M12 flange connector for the Modbus input and an 8-pin M12 flange connector for the switch outputs.

The DE91 can be connected to a Modbus RTU network as a so-called slave. Up to 247 devices can be addressed in one line network. It is connected via a conventional T-piece (passive TAP).

NOTICE! Star-shaped networks are not allowed.

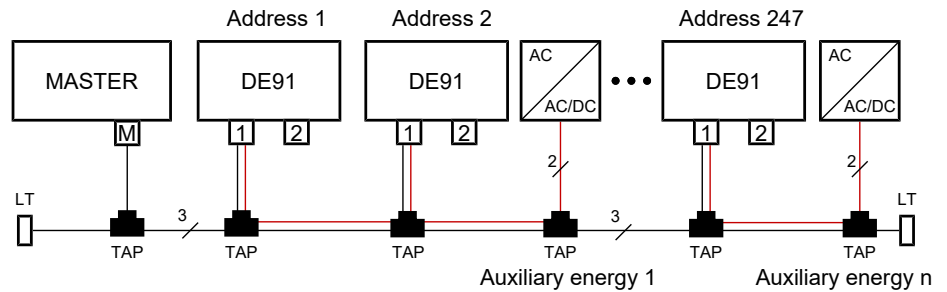

Fig. 31: Modbus RTU network

Communication takes place solely with the Modbus master. The connected slaves only react to direct commands from the master, so communication between the slaves is not possible.

To guarantee fault-free data transmission, we recommend terminating the end point of the Modbus RTU network with a 120 Ω resistor. This bus termination resistor is available as an accessory.

3.4.5.1 Connection to an existing Modbus RTU network

It can be connected to an existing Modbus network via a conventional T-piece (passive TAP).

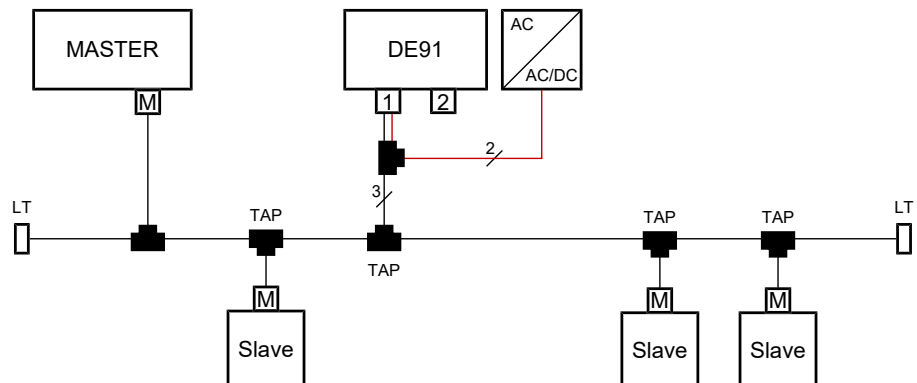

Fig. 32: Modbus connection

3.4.5.2 Auxiliary energy supply

The following illustrations explain the principle of the power supply of the DE91 in the Modbus network. However the feeder nodes are not part of the delivery scope and need to be installed by the operator.

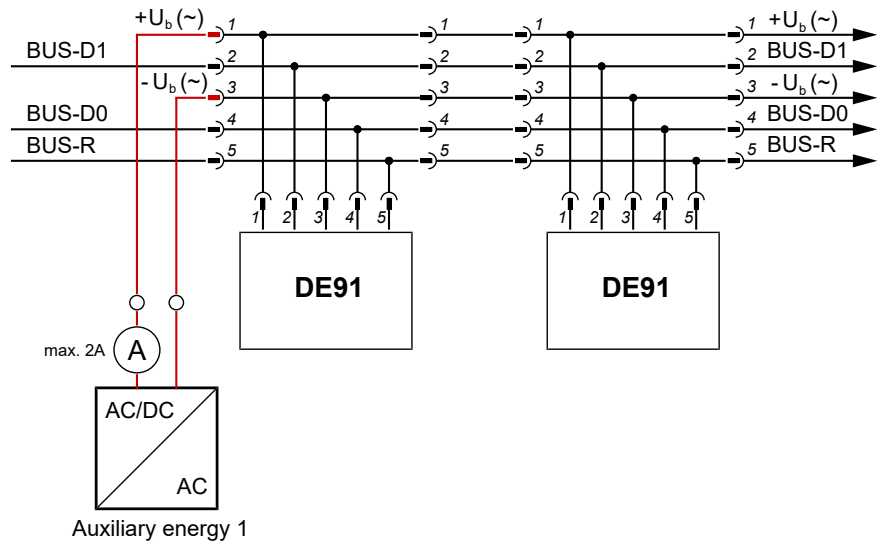

Fig. 33: Main supply

Please note that the M12 connectors are approved for max. 2A. This value may already be exceeded if there are more than 12 devices of type DE91. In this case, an intermediate auxiliary energy feed should be provided at a suitable place.

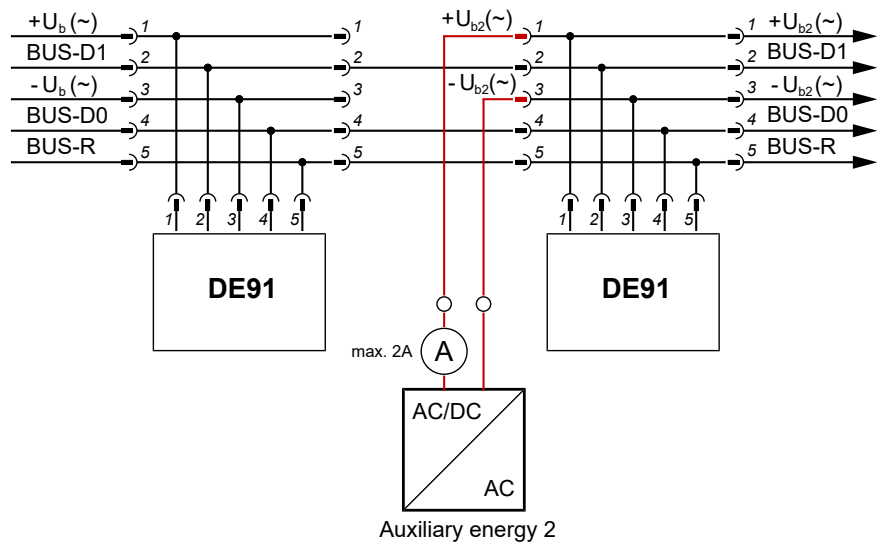

Fig. 34: Intermediate supply

3.4.5.3 M12 connector 1: Modbus

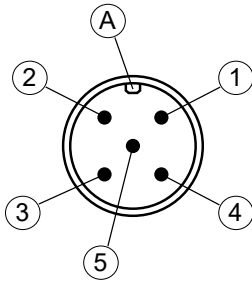

Fig. 35: M12 plug 5-pin

PIN	Signal		Cable colour
1	Operating voltage	+U _b	Brown
2	Modbus	BUS-D1	White
3	Operating voltage	- U _b	Blue
4	Modbus	BUS-D0	Black
5	Modbus	BUS-R	Grey
A	Coding		

3.4.5.4 M12 connector 2: Switch outputs

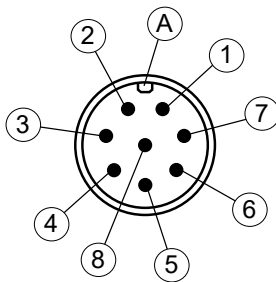

Fig. 36: 8-pin M12 connector

PIN	Signal		Cable colour
1	Switch output 1	SP1	White
2	Switch output 1	SP1	Brown
3	Switch output 2	SP2	Green
4	Switch output 2	SP2	Yellow
5	Switch output 3	SP3	Grey
6	Switch output 3	SP3	Pink
7	Switch output 4	SP4	Blue
8	Switch output 4	SP4	red
A	Coding		

3.4.6 Devices with IO-Link

3.4.6.1 M12 connector 1: IO-Link

Supply via the IO-Link (Class A) is limited to 200 mA.

Pin assignment M12-4 Class A

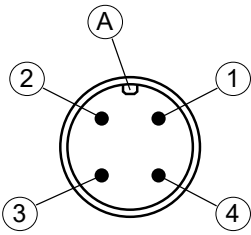

Fig. 37: M12 connector 4-pin

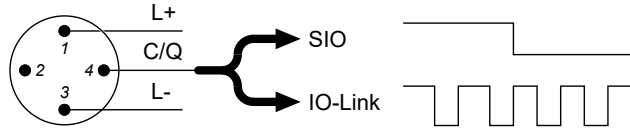

Fig. 38: IO-Link

Posi- tion	Description	Cable colour
1	L+ 24 V supply (U_{s+})	Brown
2	n.c. Not connected	White
3	L- 24 V supply (U_{s-})	Blue
4	C/Q Standard input/output (SIO) or communication line (IO-Link)	Black
A	Coding	

3.4.6.2 M12 connector 2: Switch outputs

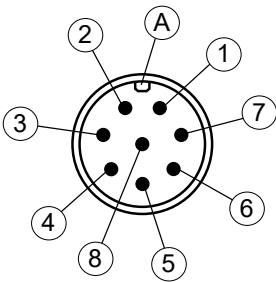

Fig. 39: 8-pin M12 connector

PIN	Signal	Cable colour
1	Switch output 1	SP1 White
2	Switch output 1	SP1 Brown
3	Switch output 2	SP2 Green
4	Switch output 2	SP2 Yellow
5	Switch output 3	SP3 Grey
6	Switch output 3	SP3 Pink
7	Switch output 4	SP4 Blue
8	Switch output 4	SP4 red
A	Coding	

3.4.7 USB port

There is a micro USB connection for a USB stick inside the housing. The parameters can be secured and loaded or the firmware can be updated via this USB interface.

The device can be configured via this interface using the PC software '**in-Touch**'⁽²⁾.

The two lid screws need to be removed to open the housing.

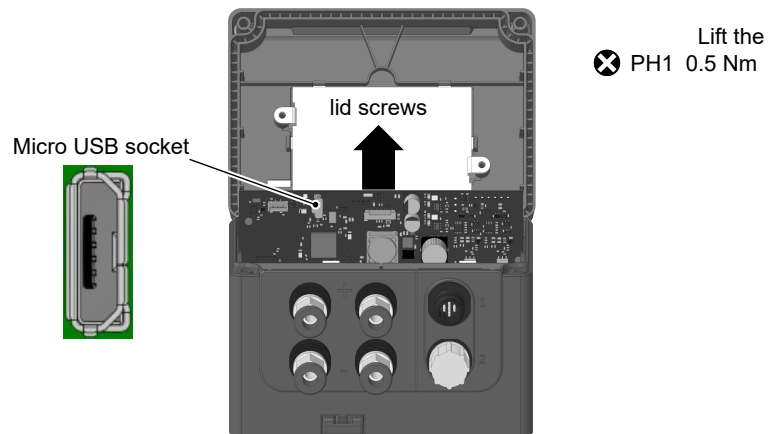

Fig. 40: USB port (example)

⁽²⁾ see accessories

4 Start-up

4.1 Installation control

Before starting the measuring device:

- ▷ Check that the pressure lines are mounted correctly.
 1. Is the measuring device undamaged?
 2. Does the measuring device fulfil the requirements of the measuring point specification?
 3. Are the pressure lines mounted correctly?
 4. Are the attachment screws tighten correctly?
 5. Is the device adequately protected against precipitation and solar radiation?

- ▷ Check that all electrical supply and measuring lines are installed correctly.
 1. Are the connection lines undamaged?
 2. Do the cables used fulfil the requirements?
 3. Is there strain relief on the mounted cables?
 4. Are the connection plugs mounted correctly?
 5. Is the ground connected correctly?

4.2 Switch on the measuring device

- ▷ The measuring device can be switched on after a successful installation check.
 1. The start screen is now shown on the display.

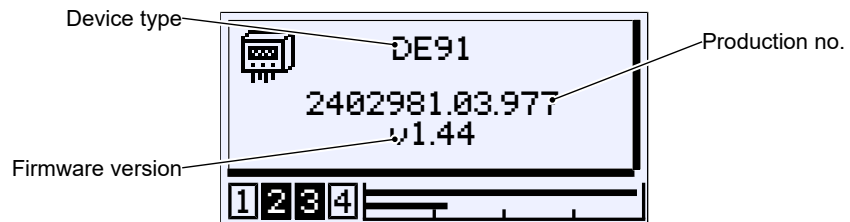

- ↪ After a successful start, the start screen switches to the measurement data display.

4.2.1 Measured value display

Depending on the unit model, there are different presentation variants for the measured value display.

4.2.1.1 1 channel version

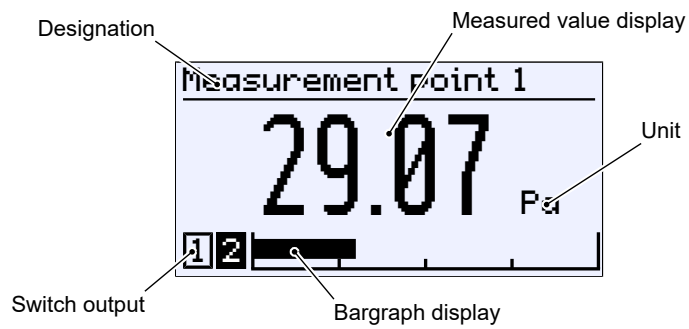

Fig. 41: Measured value display (1-channel)

4.2.1.2 2 channel version

The presentation can be modified using the **Meas.data display** menu. Both channels can be shown individually or at the same time. The bargraph display always shows the two measuring channels.

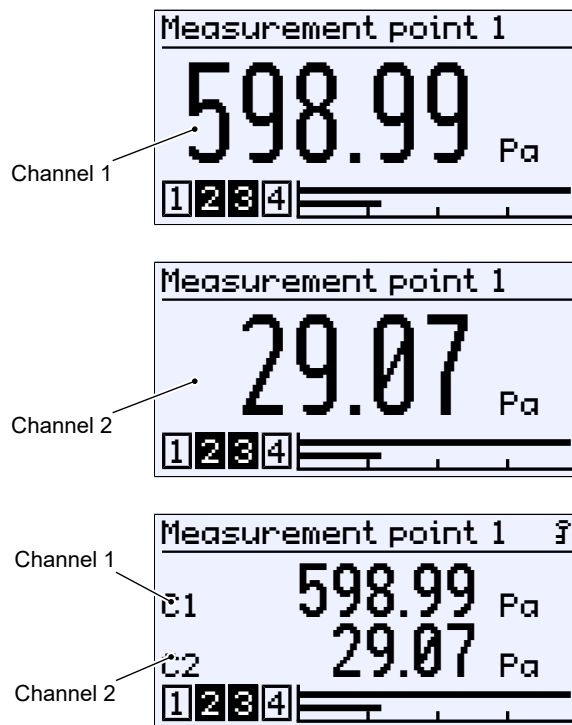

Fig. 42: Measured value display (2-channel)

4.2.1.3 3 channel version

The 3-channel display is only available for the 'Difference' and 'Dynamic filter monitoring' functions. Channel 3 is a so-called *virtual channel*. The displayed value is calculated from the measured values of channels 1 and 2.

The display can be adapted via the **Meas.data display** menu. Three channels can be displayed simultaneously or individually. The bar graph display always shows all three measuring channels.

Difference:

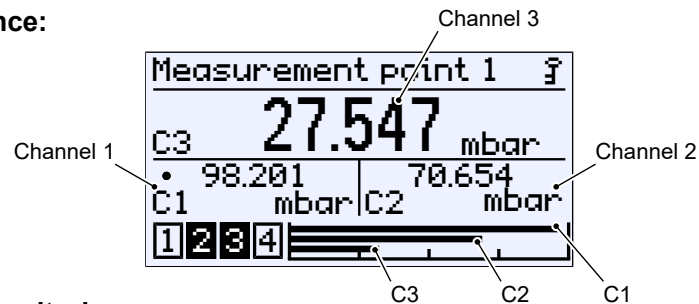

Filter monitoring:

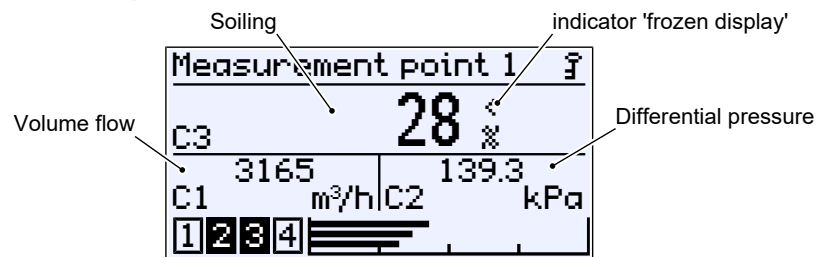

Fig. 43: Measured value display (3 channel)

4.2.1.4 Back lighting

The LC display is equipped with RGB back lighting. This allows it to create various coloured backgrounds for the measuring data display.

Also, the so-called colour changes can be configured that serve to indicate when limits have been overstepped.

For more information, please go to menu display [▶ 97] and/or colour change [▶ 71].

4.2.2 Keyboard

The basic functions of the keyboard are explained in this section. For more information about the operating concept, please see the section 'first steps'.

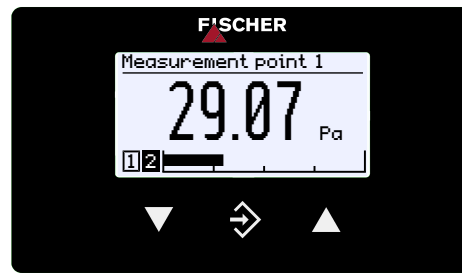

Fig. 44: Operating keys

▼	Page down menu	Decrease value	
⇨	Call up menu	Save value	Return jump
▲	Page up menu	Increase value	

The buttons are always pressed individually. Combinations, such as pressing two buttons at the same time or similar, are not used.

The button can be actuated in two ways. IN the following, the adjacent symbols indicate the actuation type.



1. Pressing briefly calls up an immediate reaction to the pushed button.
2. If the button is pressed for longer than 250 ms, the reaction is a repetition of the pressed button, hereinafter called 'Repeat'. If the button is pressed permanently, the repeat is carried out in a continuous sequence. However, there is no acceleration.
3. Automatic stop at the menu item **Back** : Permanent pushing of the button ▼ or ▲ returns the user to the menu item **Back** very quickly. The stop is automatic there.
4. Jump back to the operating display: Permanent pressing of the button ⇨ takes the user from the menu item **Back** into the operating screen.

4.3 Setup

The measuring device is completely configured in the factory before delivery. Nevertheless, all parameters can be adjusted directly on site using the keypad. Optionally, a configuration can also be created on the PC using the inTouch© software and transferred to the device via the USB interface.

4.3.1 Set menu language

Works setting: German or ordered national language

- ▷ The menu language can be changed as follows.
 1. You have the right to change the configuration.
 2. Log in to the device and go to the menu **Configuration** and then to the menu **Display**.
 3. There, open the menu **Language** and change the menu language.

4.3.2 Measuring point designation

- ▷ A designation for the measuring point can be filed to identify the device within a system.
 1. You have the right to change the configuration.
 2. Log in to the device and go to the menu **Configuration** and then to the menu **Display**.
 3. Change the **Designation** parameter.

4.3.3 Configuration

The measuring device is delivered in the configuration stated in the Order code.

- ▷ Do you want to adjust the parameters on the device on site?
 1. You have the right to change the configuration.
 2. Log in to the device and call up the menu **Configuration**.
 3. Carry out the required changes.

- ▷ The PC software **inTouch**® can be used for making more comprehensive changes to the configuration.
 1. Carry out the changes on the PC using the inTouch software.
 2. Transfer the configuration to the device via the USB interface.

4.4 Modbus RTU interface

The DE91 can also be delivered with a Modbus interface. This communication interface is set in the menu 'Modbus RTU [▶ 102]'.

4.5 IO-Link Interface

The DE91 can also be delivered with an IO-Link interface. Default settings for this interface are completed at the factory. The associated IODD and a description of the interface are available in the download area of the FISCHER website (www.fischermesstechnik.de).

5 Operation

5.1 First steps

5.1.1 Passwords



NOTICE

Publicly accessible passwords

By publishing the passwords in these operating instructions, the parameterisation is accessible to everyone. Within the scope of security, it is absolutely necessary for the operator of the plant to issue new passwords for all user types.

The manufacturer is not liable for damages resulting from changes to a parameterisation.

The following passwords are assigned when the unit is delivered.

User	Password
User 1	000
User 2	000
User 3	000
Administrator	000



Users 1, 2, and 3 are disabled at delivery and must be explicitly enabled by the user. The administrator user can change all passwords in the respective menu *Login > User Management > User # > User # Passwords* .

If the same passwords are assigned, priority is given when logging in:

Administrator > User 1 > User 2 > User 3

Using the *Login > Reset Passwords* function, the administrator user can reset all passwords to the factory setting 000.

See also

-  Manage users [▶ 50]
-  Reset passwords [▶ 53]

5.1.2 Operating modes

Operating mode

After activation, the device automatically starts. The device works according to its configuration.

Configuration mode

Pressing the button  takes the user from the operating mode to the configuration mode. The device is still operational and works according to its configuration. All parameter changes have a direct effect on how the device operates.

If the device is configured via the USB interface, operation is interrupted when transmission starts. Operation starts with the new configuration after transmission. The transfer lasts just a few milliseconds.

5.1.3 Menu tree

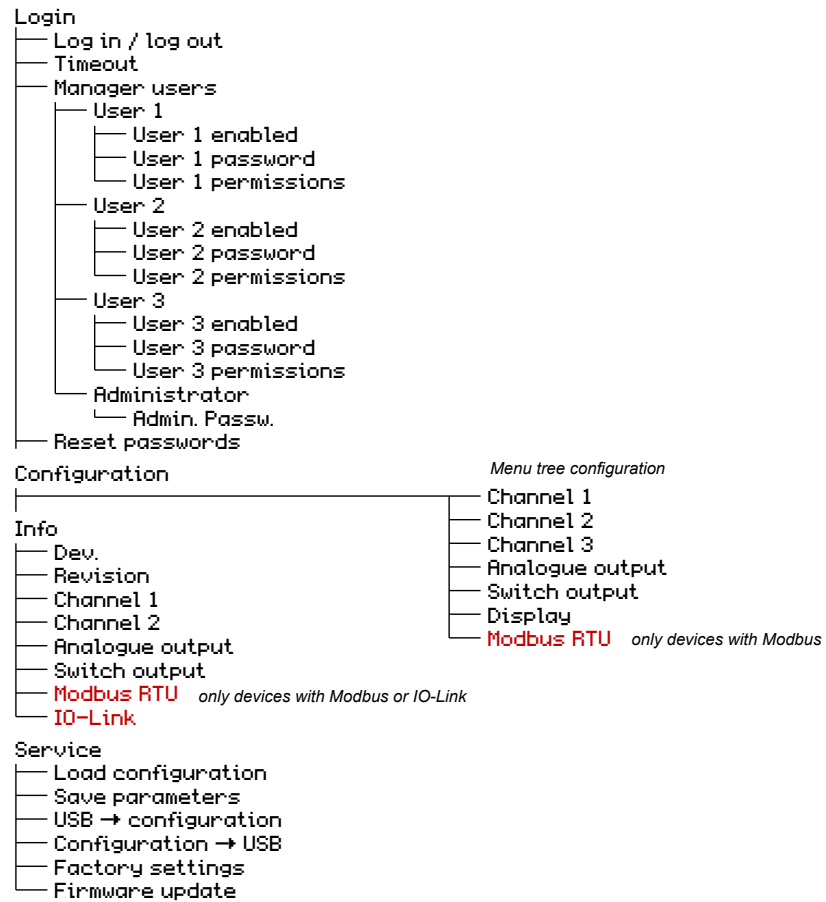
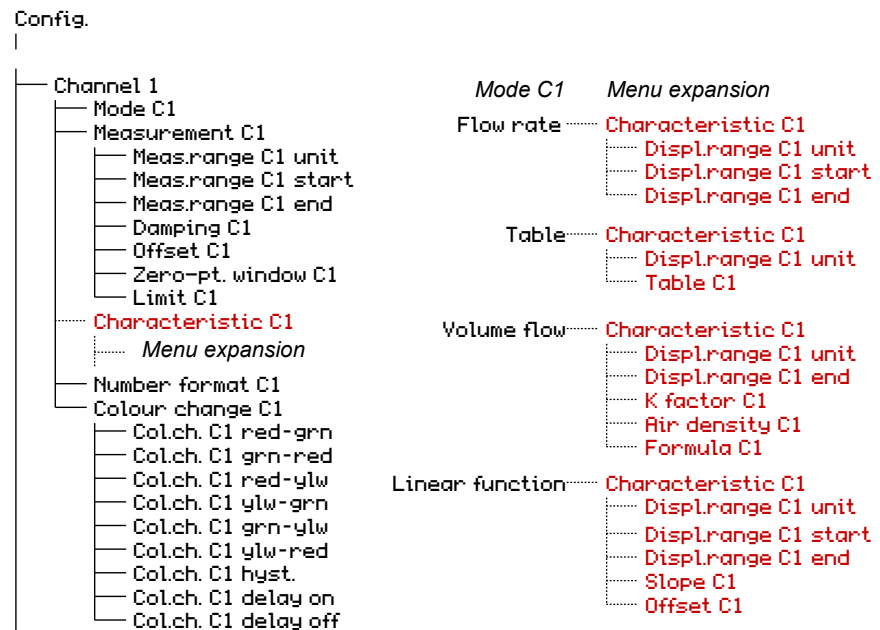

Fig. 45: Menu tree

Menu tree configuration

Channel 1



Channel 2

- Channel 2
 - Mode C2
 - Measurement C2
 - Meas.range C2 unit
 - Meas.range C2 start
 - Meas.range C2 end
 - Damping C2
 - Offset C2
 - Zero-pt. window C2
 - Limit C2
 - Characteristic C2
 - Menu expansion
 - Number format C2
 - Colour change C2
 - Col.ch. C2 red-grn
 - Col.ch. C2 grn-red
 - Col.ch. C2 red-ylw
 - Col.ch. C2 ylw-grn
 - Col.ch. C2 grn-ylw
 - Col.ch. C2 ylw-red
 - Col.ch. C2 hyst.
 - Col.ch. C2 delay on
 - Col.ch. C2 delay off

- Mode C2 Menu expansion
- Flow rate Characteristic C2
 - Displ.range C2 unit
 - Displ.range C2 start
 - Displ.range C2 end
- Table Characteristic C2
 - Displ.range C2 unit
 - Table C2
- Volume flow Characteristic C2
 - Displ.range C2 unit
 - Displ.range C2 end
 - K factor C2
 - Air density C2
 - Formula C2
- Linear function Characteristic C2
 - Displ.range C2 unit
 - Displ.range C2 start
 - Displ.range C2 end
 - Slope C2
 - Offset C2

Channel 3

- Channel 3
 - Mode C3
 - Measurement C3
 - Meas. range C3 unit
 - Meas. range C3 start
 - Meas. range C3 end
 - Damping C3
 - Offset C3
 - Zero-pt. window C3
 - Limit C3
 - Formula C3
 - Characteristic C3
 - Menu expansion
 - Number format C3
 - Colour change C3
 - Col.ch. C3 red-grn
 - Col.ch. C3 grn-red
 - Col.ch. C3 red-ylw
 - Col.ch. C3 ylw-grn
 - Col.ch. C3 grn-ylw
 - Col.ch. C3 ylw-red
 - Col.ch. C3 hyst.
 - Col.ch. C3 delay on
 - Col.ch. C3 delay off

- Mode C3 Menu expansion
- +Flow rate Characteristic C3
 - Displ.range C3 unit
 - Displ.range C3 start
 - Displ.range C3 end
- +Table Characteristic C3
 - Displ.range C3 unit
 - Table C3
- Dyn. filter monitor: Characteristic C3
 - Displ.range C3 start
 - Displ.range C3 end
 - Channel Δp
 - Channel Q
 - Approximation
 - Δp clean
 - Δp soiled
 - Δp correction value
 - Max. volume flow
 - Min. volume flow
 - Table
 - Min. soiling
 - Damping C3

Analogue output

- Analogue output
 - An.output 1 type
 - An.output 1 assignmt
 - An.output 2 type
 - An.output 2 assignmt
 - Limit I min.
 - Limit I max.
 - I fault
 - Limit U min.
 - Limit U max.
 - U fault

Switch output**Display****Modbus RTU**

Fig. 46: Menu tree configuration

5.1.4 Navigation in the menu tree

Pressing the button ⇨ takes the user from the measured value display to the main menu.

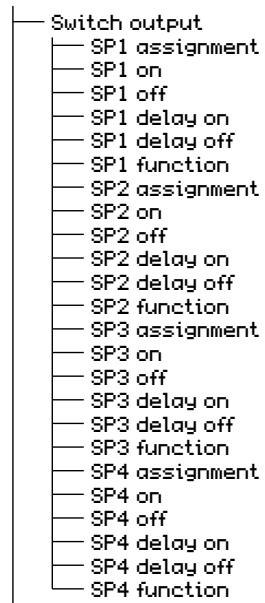
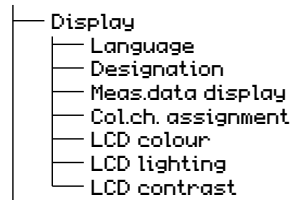
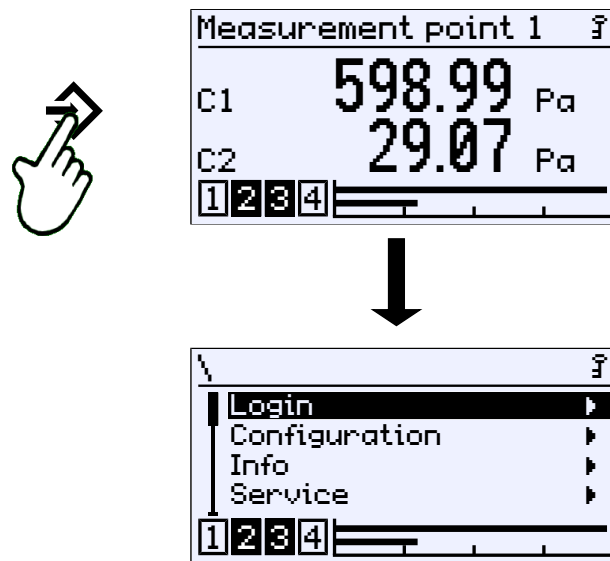

Fig. 47: Call up the main menu (Level 0)

The menu has up to five levels called 'Level' hereinafter. The levels are numbered from 0 to 4. Level 0 is the main menu. No distinction is made between the menu and the parameters in this presentation. However, a menu can be recognised on the indicator ▶ .

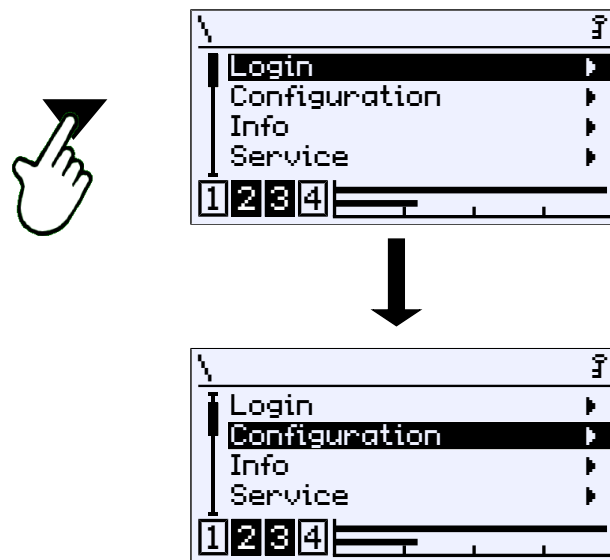

Fig. 48: Page down menu (Level 0)

The buttons ▼ and ▲ are used to move the cursor through the menu. The button ⇨ opens the menu and the submenu of the next level appears on the display.

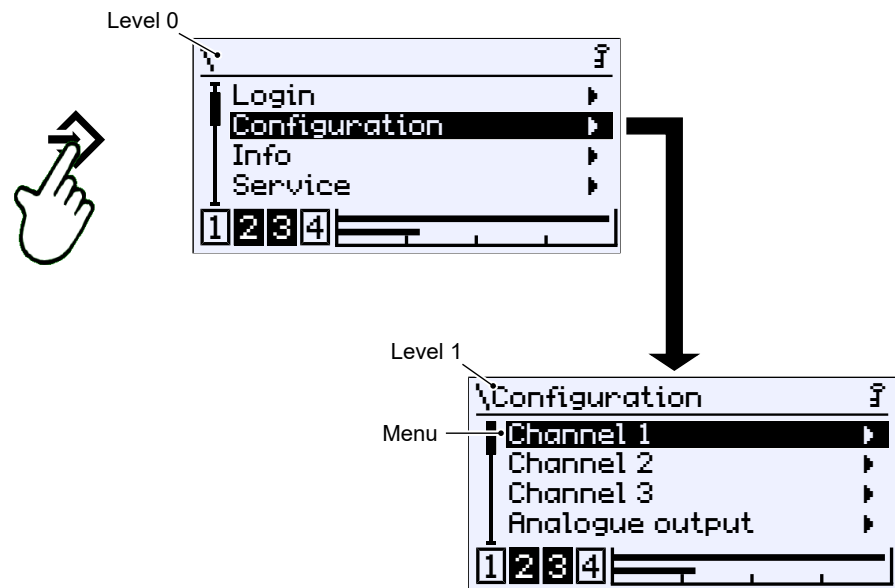

Fig. 49: Sideways in submenu (Level 1)

To leave the menu, the cursor needs to be moved to the menu item **Back** . Pressing this button ⇨ returns the user to the next highest level.

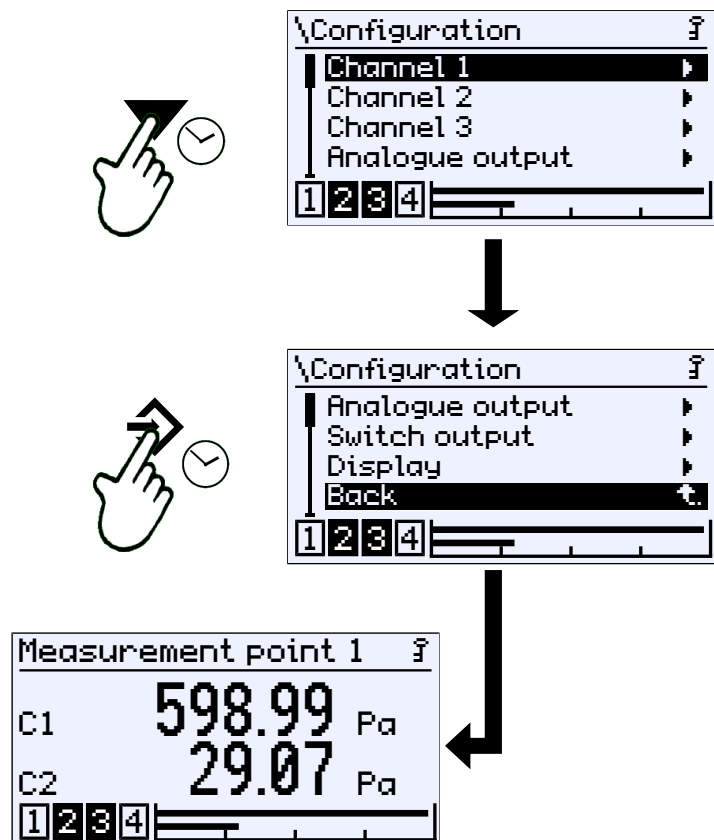

Fig. 50: Page down to output

It is of course possible to move down the menu to the menu item **Back** .

5.1.5 Path details

The path information appears in the first line of the display. For space reasons, the path cannot be shown in full. The menu level is indicated by the number of backslash symbols '\'. Where this is not possible, only the menu name is shown.

Path: \Configuration\Channel2\Measurement C2\Meas.range C1 unit
 ↑Level 0 ↑Level 1 ↑Level 2 ↑Level 3

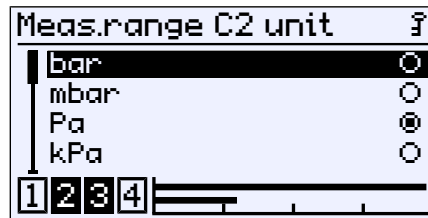

Fig. 51: Path

5.1.6 Input

The following softkeys are used whenever text or values are entered:

- **Edit**
 This softkey is used to switch into the editing window for entering text or values.
- **OK.**
 The input is completed with this softkey. The entered text or value is saved.
- **Cancel**
 The input is cancelled with this softkey. The originally saved text or value is retained.

A softkey is pressed by first being selected with the buttons ▼ and ▲. The softkey is shown inverted. It is realised with the button ⇨.

5.1.6.1 Text input

For example:

Path: \Configuration\Display\Designation

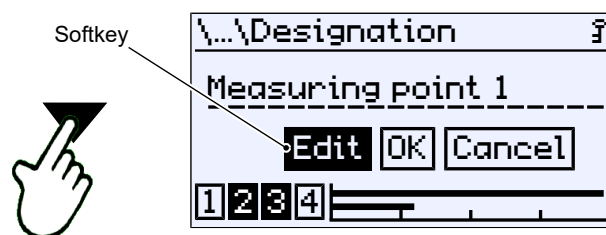

Fig. 52: Action selection

Select the softkey **Edit** with the buttons ▼ or ▲. The selection is confirmed with the button ⇨. The following window opens for editing.

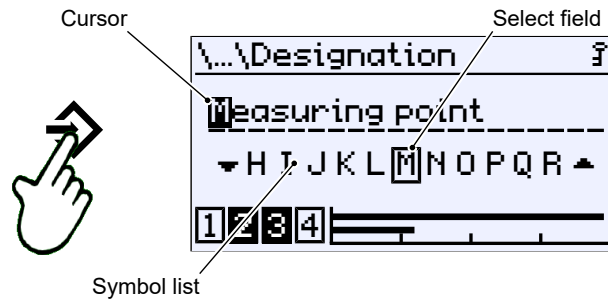

Fig. 53: Editing text

In this display, the cursor is controlled with the button \rightleftarrows . The cursor can only be moved right. It is not possible to move back. If the cursor is moved to the edge, the display for selecting the action (see above) is displayed again.

Text is processed with the select field in combination with the latest cursor position. The button \blacktriangledown moves the list of characters⁽³⁾ to the left and the button \blacktriangleup moves it to the right. If the right sign is shown in the select field, these can be accepted with the button \rightleftarrows at the cursor position. The cursor moves one character to the right and the next character position can be edited.

5.1.6.2 Value input

For example:

Path: \Configuration\ Channel 1\ Measurement C1\ Meas.range C1 start

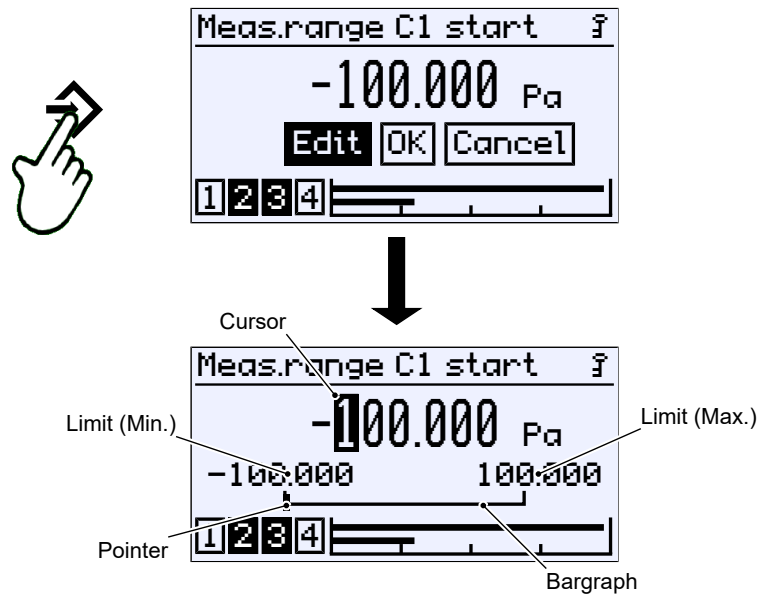

Fig. 54: Input of number values 1st place

Partial input

The number value can be entered position by position from left to right. The buttons \blacktriangledown and \blacktriangleup are used to set the numbers 0 ... 9. The sign can be changed automatically by selecting the running direction. The limit values determined from the device configuration cannot be undercut or exceeded. One of the set digits can be accepted with the button \rightleftarrows and the cursor moves one position further to the right. The running direction of the cursor is defined and cannot be changed.

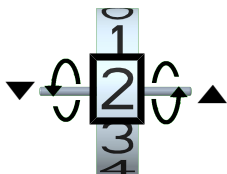

Fig. 55: Setting a figure

⁽³⁾ The list of characters comprises the characters of the character set Windows 1252 (Latin 1 and Latin 9)

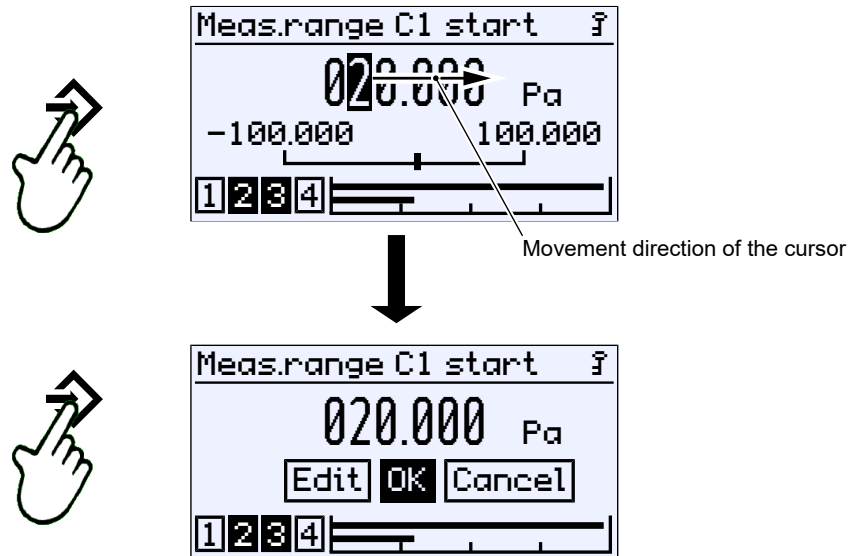

Fig. 56: Input of number values 2nd place

The button repeat ⇄ automatically returns the user to the action selection. Pressing the button again will save the value.

Number overflow

If the number 9 is set to one position and if the button ▲ is pressed again, a number overflow occurs. In this example, the value is counted up from 29 to 30. Pressing the button ▲ permanently (repeat), the value increases gradually like a counter.

Counting is realised in the opposite direction by pressing the button ▼. The value is negative after zeroisation.

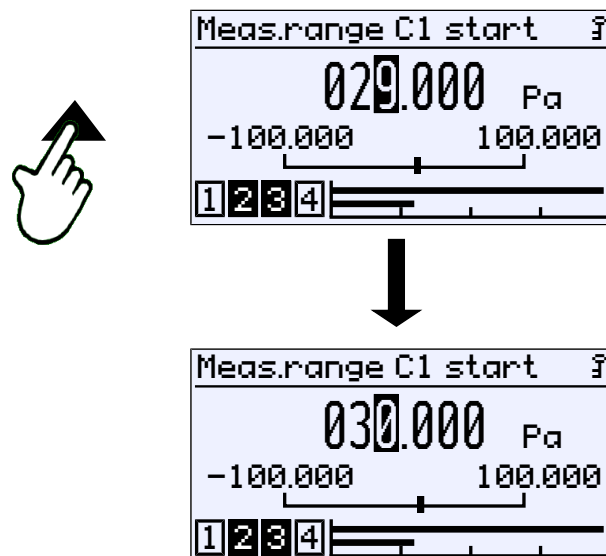

Fig. 57: Number overflow

The value is always counted upwards from the cursor position. If, for example, the cursor is on the first decimal place, the value is counted upwards from here: 29.0 → 29.1 → 29.2 ...

If, in contrast, the cursor stands on the last point, counting is realised as follows. 29,000 → 29,001 → 29,002 ... up to overflow 29,999 → 30,000 ...

5.1.6.3 Selection of options

For example:

Path: \ Configuration \ Channel 2 \ Measurement C2 \ Meas.range C2 unit

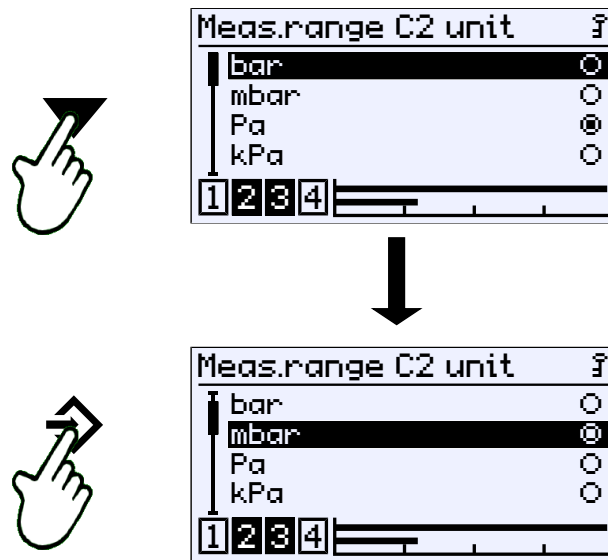

Fig. 58: Entry of options

The cursor is moved with the buttons ▼ and ▲. Only one of the offered options can be selected. The button ⇄ is used to select the option marked by the cursor.

The menu exit 'back' button is used to return to the called-up the menu. The selected option is accepted.

5.2 Main menu

Path: \
Level: 0

Pressing the button ⇨ takes the user from operating mode to configuration mode. The main menu is displayed. The bar graph display and display of the switch outputs still remain visible.

NOTICE! The device also remains operational during configuration. All parameter changes have a direct effect.

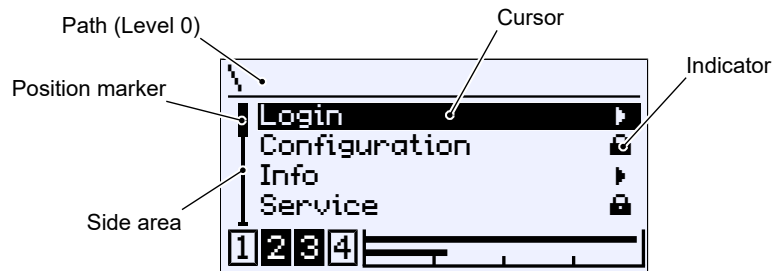

Fig. 59: Main menu

The indicator ▶ shows that there is a submenu on the following level. The main menu comprises the following menus:

Menu name	Description
Login	▶ In this menu, users can log in and out as well as manage passwords.
Configuration	▶ The device is configured using this menu. There are up to four menu levels.
Info	▶ This menu contains information about the hardware and software of the device and its configuration.
Service	▶ The firmware of the device can be un-dated and parameters can be loaded and saved with this menu.
Back	⬅ This is the exit level of the main menu. It takes you 'Back' to the 'Meas. data display' screen.



Signposts [▶ Page]

- Login [▶ 48]
- Configuration [▶ 54]
- Info [▶ 105]
- Service [▶ 106]

5.3 Login

Path: \Login

Level: 1

Users that are not logged on only have access to the information menu. Users must log in to gain access to the configuration.



Fig. 60: Login

The login menu consists of the following parameters and submenus:

Menu name	Description
Log in / log out	Users can login and off with this menu item.
Timeout	The timeout function is defined with this parameter.
Manage users	▶ This submenu serves to manage users and passwords.
Reset passwords	This menu item is used to reset all passwords to 000 .
Back	⬅. This represents the output (exit) of the login menu. Press 'back' to return to the main menu.

5.3.1 Log in / log out

Path:\Login\ Log in
Level: 2

Login is realised by entering a number. After entering the correct password, the menus to which the users have access rights are unlocked.

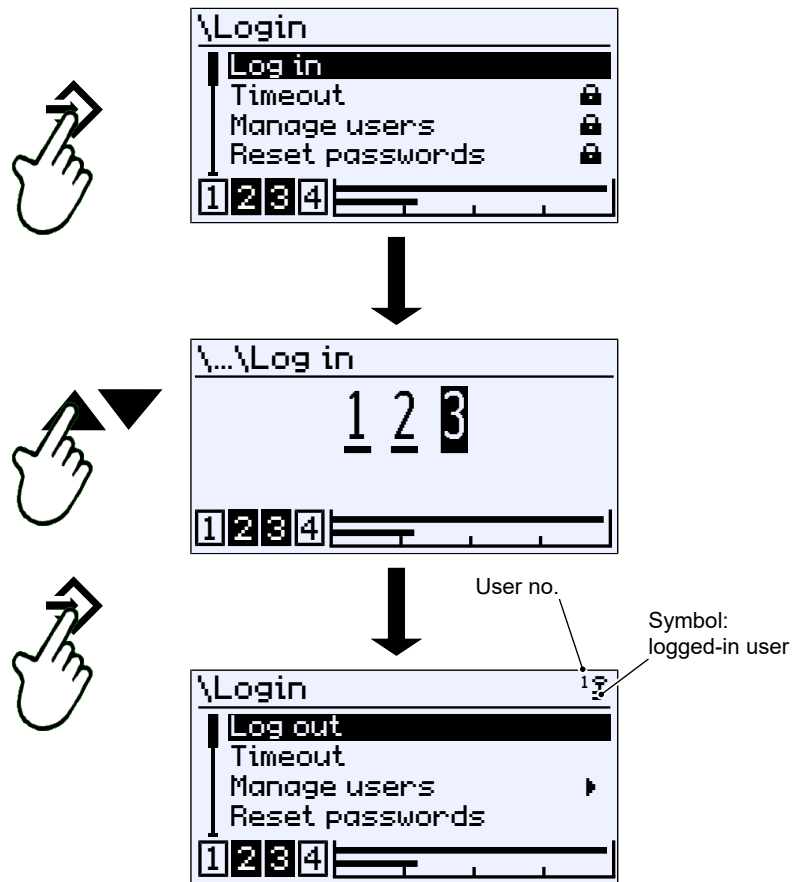

Fig. 61: Log in

Users log out by selecting the corresponding menu item and confirming with the button \Rightarrow . A key in the top right corner of the display signals the logged-in user.

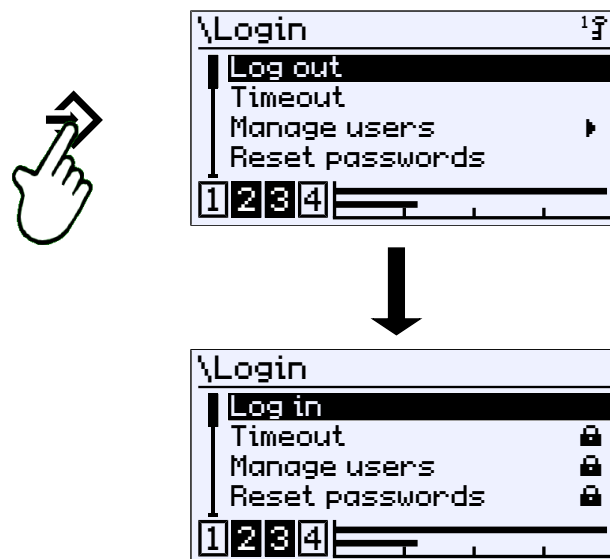

Fig. 62: Log out

5.3.2 Timeout

Path: \Login\Timeout

Level: 2

If the device is switched to configuration mode and no button is pressed, the device returns to the operating mode after the expiry of a defined time period. This time range is set with the parameter **Timeout**.

Values entered in minutes. The value range covers 0 ... 60 min. When the value 0 is entered, the timeout function is switched off.

After the set timeout time has expired, a logged in user is logged off whilst the device switches to the operating mode.

If, however, the timeout function is deactivated, the user remains permanently logged in. Users must log off manually.

The key symbol should indicate this possibly undesirable status.



5.3.3 Manage users

Path: \Login\Manage users

Level: 2

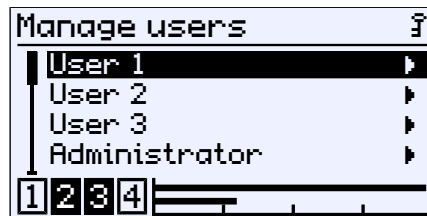

Fig. 63: Manage users

The login menu consists of the following parameters and submenus:

Menu name	Description
User 1	▶ This menu item is used to manage the rights of the respective user.
User 2	▶
User 3	▶
Administrator	▶ The password for the administrator is defined in this menu.
Back	⬅ This represents the output (exit) of the 'Manage users' menu. Press 'back' to return to the main menu.

The menus for the users are identical, therefore the menu for user 1 is described for all.

5.3.3.1 User 1

Path: \Login\ Manage users \ User 1
 Level: 3

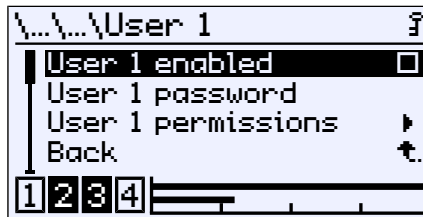

Fig. 64: User 1

Menu name	Description
User 1 enabled	<input type="checkbox"/> The user can be enabled with this parameter.
User 1 password	The password for user 1 is defined with this parameter.
User 1 permissions	<input type="checkbox"/> The permissions of user 1 is defined with this parameter.
Back	<input type="checkbox"/> This represents the output (exit) of the User 1 menu. This is used to return to the 'Manage user' menu.

The parameter **User 1 enabled** release user 1:

- User deactivated
- User activated

The password for the user is issued with the parameter **User 1 password** . A password 000 is issued with the default setting. Only numerical passwords from 000 to 999 can be used.

5.3.3.1.1 User 1 permissions

Path: \Login\ Manage users \User 1\ User 1 permissions
 Level: 4

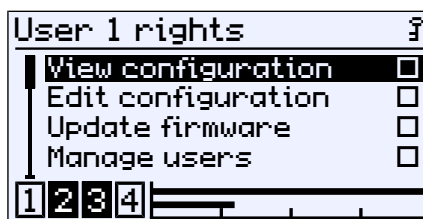

Fig. 65: User 1 permissions

Menu name	Description
View configuration	<input type="checkbox"/> The reading rights are set with this parameter.
Edit configuration	<input type="checkbox"/> The writing/reading rights are set with this parameter.
Firmware update	<input type="checkbox"/> The update rights are set with this parameter.
Manage users	<input type="checkbox"/> The user management rights are set with this parameter.
Back	<input type="checkbox"/> This represents the output (exit) of the User 1 permissions menu. Press 'back' to return to the User 1 menu.



The parameter **View configuration** is used to define whether the user may read the configuration. Activation of the reading rights is indicated with the symbol of a crossed-out pencil. This should display the missing writing rights.



The writing/reading rights are issued with the parameter **Edit configuration**. These rights allow the user to change the configuration. Access to the service menu is allowed. However, the right to manage users and update the firmware remains blocked.

The right to update the firmware is issued with the parameter **Update firmware**.

The right to change user rights is issued with the parameter **Manage users**.

A user with all rights has **no** access to the administrator menu, nor may he reset the passwords to default settings.

5.3.3.2 Administrator

Path: \Login\ Manage users \Administrator

Level: 3



Fig. 66: Administrator

The password for the administrator is issued with the parameter **Admin.password**. The administrator has unlimited access to all menus and parameters.

5.3.4 Reset passwords

Path: \Login\ Reset passwords

Level: 2

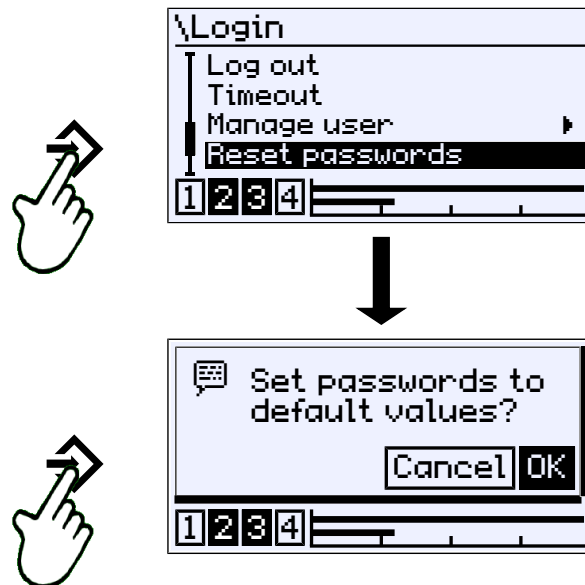

Fig. 67: Reset passwords

All passwords are set to the default value 000. Only the administrator can carry out this action. The set rights of the users are retained.

5.4 Configuration

The device can also be configured on a PC with the **inTouch®** software. The finished parameter set is then transferred to the device via the USB interface.



⚠ WARNING

Configuration in potentially explosive areas

The housing may not be opened within the ATEX area. This means that configuration and firmware updates via the USB interface are only possible outside the potentially explosive area.

*Path: \Configuration
Level: 1*

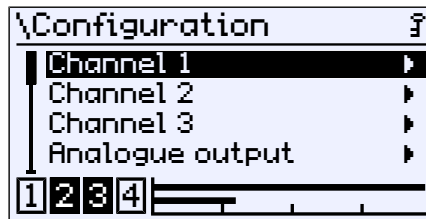

Fig. 68: Configuration

NOTICE! Depending on the model, the device has 1 or 2 measuring channels. In devices with just one measuring channel, the menus for the second channel are hidden.

The parameters and menus are described for a device with two channels. Therefore, the displays and descriptions shown may vary for a device with just one channel.

Only devices with two channels have a third channel. This channel is a “virtual” channel whose display values are calculated by a mathematical function from the two measuring channels 1 and 2.

Menu name	Description
Channel 1	▶ This menu is used to configure the 1st measuring channel.
Channel 2	▶ This menu is used to configure the 2nd measuring channel.
Channel 3	▶ This menu is used to configure the 3rd measuring channel.
Analogue output	▶ The analogue outputs are configured with this menu.
Switch output	▶ The switch outputs are configured with this menu.
Display	▶ This display is configured with this menu.
Modbus RTU	▶ This menu is available for Modbus devices only. It enables the configuration of the interface.
Back	⬅ This is the exit point of the configuration menu. It takes you “Back” to the main menu.

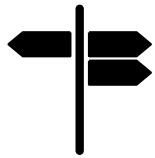
**Signpost [▶ Page]**

- Channel 1 [▶ 56]
- Channel 2 [▶ 77]
- Channel 3 [▶ 77]
- Analogue output [▶ 91]
- Switch output [▶ 94]
- Display [▶ 97]
- Modbus RTU [▶ 102]

5.4.1 Channel 1

Path: \Configuration\Channel 1
Level: 2

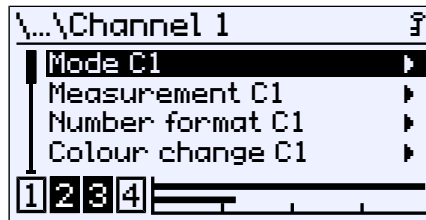

Fig. 69: Channel 1

Menu extension

Menu name	Description
Mode C1	▶ With this menu you can select fixed functions for the measuring channel.
Measurement C1	▶ In this menu the input of the measuring channel is parameterized.
Characteristic C1	▶ This menu is hidden depending on the selected mode.
Number format C1	▶ In this menu, the decimal places for the measured value display of the measuring channel are set.
Colour change C1	▶ In this menu the colour changes for the measuring channel are parameterized.
Back	⌂ This represents the output (exit) of the menu. This takes you 'Back' to the parameterization menu.

The following graphic illustrates the interaction of the various parameters.

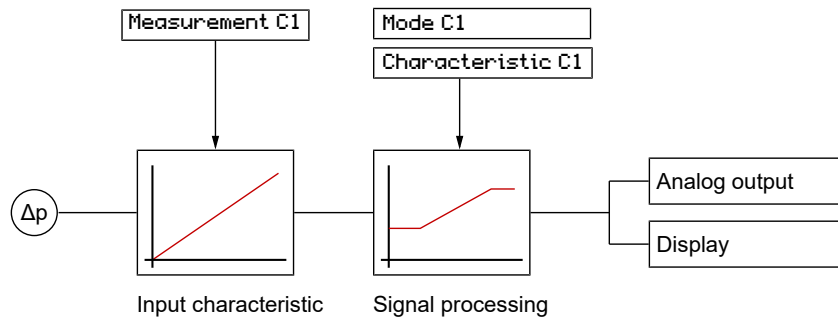
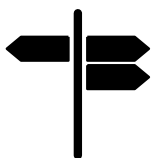

Fig. 70: Parameterization of characteristic K1

Signpost [▶ Page]

- Mode C1 [▶ 57]
- Measurement C1 [▶ 58]
- Characteristic curve C1 (menu extension) [▶ 63]
- Number format C1 [▶ 70]
- Colour change C1 [▶ 71]



5.4.1.1 Mode C1

Path: \Configuration\Channel 1\Mode C1
 Level: 3

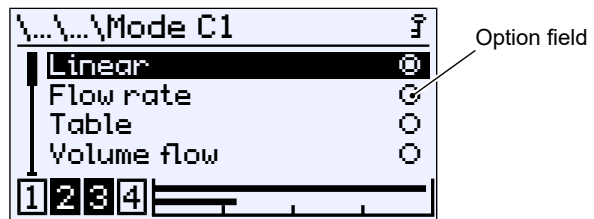

Fig. 71: Mode C1

In this menu, various modes can be selected for the first measurement channel (C1). The selected mode is indicated by the option field.

Parameter value	Description
Linear	Linear input characteristic curve
Flow rate	Flow measurements at an orifice plate
Table	Correction table of the input characteristic curve
Volume flow	Volumetric flow measurements in ventilation systems
Linear function	Mathematical function $f(x) = mx + b$
Back	This represents the output (exit) of the menu. It takes you back to the Channel 3 menu.

Each of these operating modes requires a different parameterization of the characteristic curve. After the exit of this menu, the calling menu will be supplemented by the menu extension **Characteristic C1**, which parameterize the characteristic curve.

The Linear operating mode is an exception. In this case, the menu extension is not necessary because the parameters are only set in the **Measurement C1** menu.

The **Table** parameter enables a point-by-point adjustment of the input characteristic curve. For example, the table is used for content measurements of tanks or for flow rate and volume flow measurements for dynamic filter monitoring.

See also

- Characteristic curve C1 (menu expansion) [▶ 63]

5.4.1.2 Measurement C1

Path: \Configuration\Channel 1\Measurement C1

Level: 3

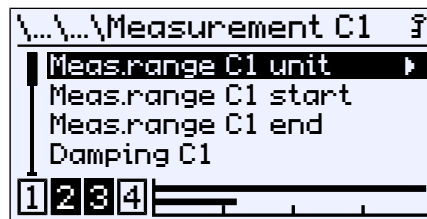

Fig. 72: Measurement C1

In this menu, the linear starting range is configured independent of the set operating mode.

Menu name		Description
Meas.range C1 unit	▶	In this menu, the measurement unit of the physical variable that is to be measured (pressure) must be defined.
Meas.range C1 start		The start of the measuring range is defined with this parameter.
Meas.range C1 end		The end of the measuring range is defined with this parameter.
Damping C1		The damping parameter serves to dampen the display.
Offset C1		The characteristic is displaced with the parameter offset.
Zero-pt. window C1		The zero point window parameter defines a range around zero in which the display value is set to zero.
Limit C1	<input type="checkbox"/>	This property determines whether or not the set measuring range limits also act on the meas.data display.
Back	⏪	This represents the output (exit) of the menu. Press 'back' to return to the channel 1 menu

5.4.1.2.1 Measuring range C1 unit

Path: \Configuration\Channel 1\Measurement C1\Meas.range C1 unit
 Level: 4

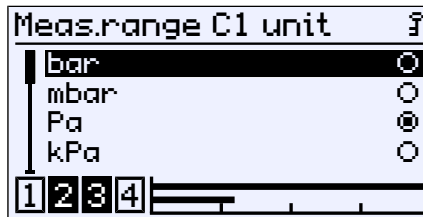

Fig. 73: Measuring range C1 unit

Implemented pressure units:

Unit	Description
bar	bar Metric and SI units
mbar	milli bar
Pa	Pascal
kPa	kilo Pascal
MPa	Mega Pascal
psi	pound-force per square inch Anglo-American units (Imperial Units)
inH ₂ O	inch water column
mmH ₂ O	mm Water column Historical units
mmHg	mm Mercury column

If the pressure unit is changed, the conversion for all parameters takes place automatically.

5.4.1.2.2 Measuring range C1 start

Path: \Configuration\Channel 1\Measurement C1\Meas.range C1 start
 Level:4



Fig. 74: Measuring range C1 start

At this point, the start value of the measuring range is entered. This input acts directly on the output signal. This does not affect the display directly.

The value range and its limits are displayed automatically.

In this works configuration, a so-called basic measuring range is defined for each device. This basic measuring range is defined by the order code and is stated on the type plate as 'Measuring range'.

With the parameters **Meas.range C1 start** and **Meas.range C1 end** the input range of measuring channel 1 is configured.

Spread (Turn down)

The characteristic can be spread within the basic measuring range. The spread is the ratio of the basic measuring range to the set measuring span and may be a maximum of 4:1. i.e. the difference of the two values **Meas.range C1 start** and **Meas.range C1 end** must be at least 25% of the basic measuring range.

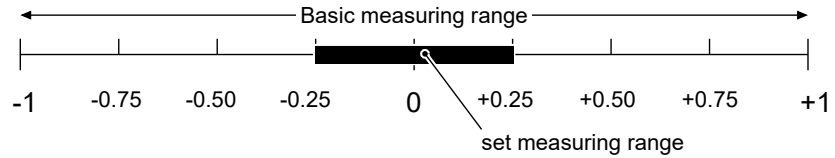

Fig. 75: Turn down

The spread of the characteristic only acts directly on the output signal. Activation of the parameter **Limit** also limits the display area to the set measuring range.

Increase in the characteristic

If the **Meas.range C1 start** < **Meas.range C1 end** leads to a rising characteristic. The output signal increases with the increasing pressure.

If the **Meas.range C1 start** > **Meas.range C1 end**, the characteristic falls. The output signal drops with the increasing pressure.

5.4.1.2.3 Measuring range C1 end

Path: \Configuration\Channel 1\Measurement C1\Meas.range C1 end
Level: 4



Fig. 76: Measuring range C1 end

At this point, the end value of the measuring range is entered. The value range and its limits are displayed automatically.

5.4.1.2.4 Damping C1

Path: \Configuration\Channel 1\Measurement C1\Damping C1
Level: 4



Fig. 77: Damping C1

If there are unsteady measurement readings during operation, you can use the parameter **Damping C1** to stabilise the reading.

The value range is from 0 to 600 s.

The parameter functions like a capillary throttle. Please note that the damping only affects the signal input. The measuring cell itself is not uninfluenced. The parameter value states the time period until the amplitude reaches 90 %. A value of 0s means that no damping is carried out.

5.4.1.2.5 Offset C1

Path: \Configuration\Channel 1\Measurement C1\Offset C1
 Level: 4

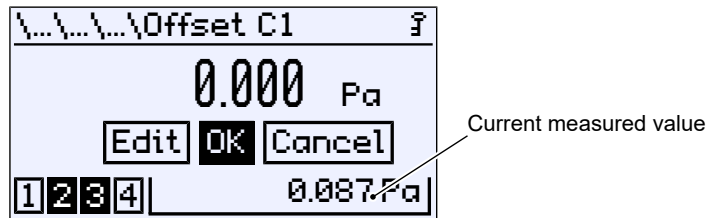

Fig. 78: Offset C1

If the measuring data display in the zero-point shows a different value, this can be corrected with the parameter **Offset C1**.

The value range is one third of the basic measuring range.

The current measurement is shown at the bottom right. During the input, the set offset parameters act immediately on the measured value. Please note that this zero-point window and the damping are not active during the offset setting.

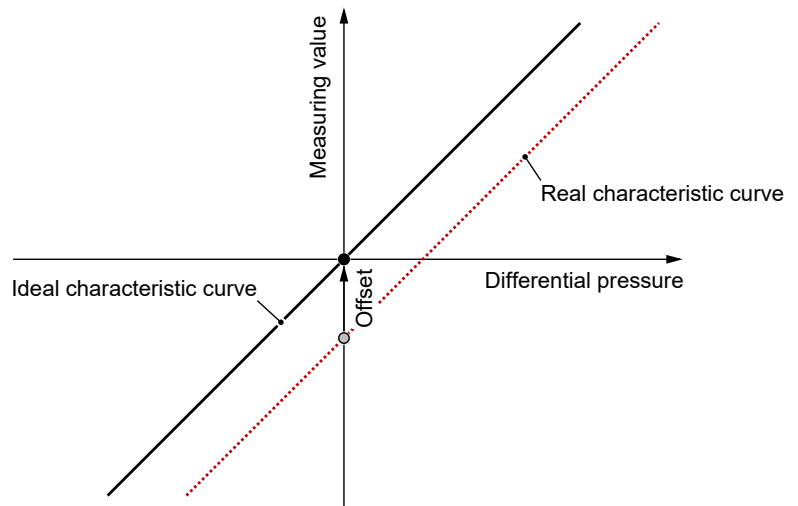

Fig. 79: Offset error

The parameter causes a shift of the entire characteristic toward the ideal characteristic.

5.4.1.2.6 Zero-point window C1

Path: \Configuration\Channel 1\Measurement C1\Zero-pt. window C1
 Level: 4



Fig. 80: Zero-point window C1

Unsteady readings are not usually a problem during normal operating mode, but this is not true for the idle state, if a measured value of zero is expected. The parameter **Zero-pt. window C1** is designed to solve this.

The value range is one third of the basic measuring range.

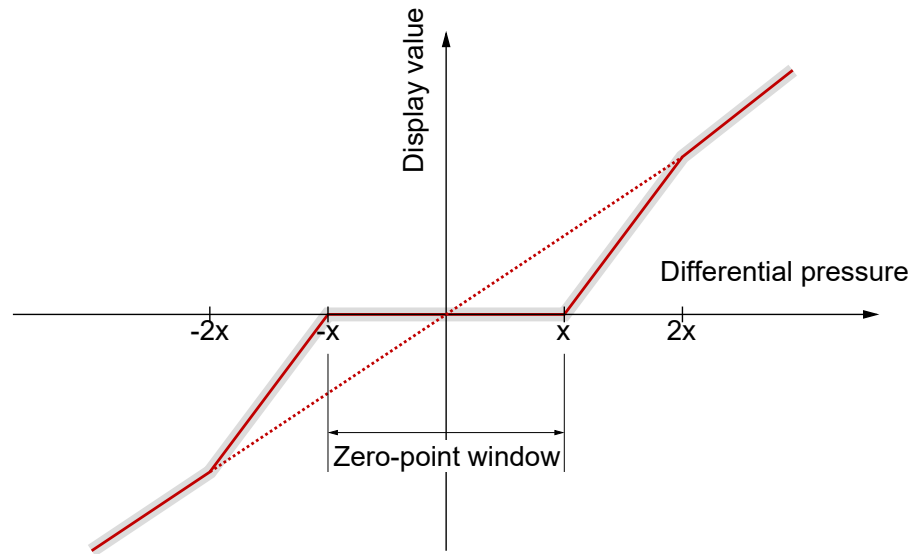

Fig. 81: Zero-point window

The parameter value (x) defines a range around zero, the so-called zero-point window. All measured values within this window are displayed as a zero value. The reading will only no longer show zero, if the pressure lies outside the set window.

In this area, approximation is linear up to twice the parameter value ($2x$). Only when twice the pressure is reached for the zero-point window, the measured value and the reading match again. This avoids jumps in the display.

5.4.1.2.7 Limits

Path: \Configuration\Channel 1\Measurement C1

Level: 3

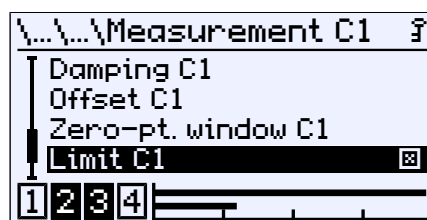

Fig. 82: Limit C1

With this property, the measuring data display can be limited to the **Meas.range C1 start** and **Meas.range C1 end** measuring range defined with the parameters. The button \Rightarrow is used to activate and deactivate.

5.4.1.3 Characteristic curve C1 (menu expansion)

The menu changes depending on the set operating mode of the measuring channel.

NOTICE! The menu extension does not apply to devices for which the Mode parameter has been set to the linear value.

5.4.1.3.1 Characteristic C1 (flow rate)

Path: \Configuration\Channel 1\Characteristic C1
Level: 3

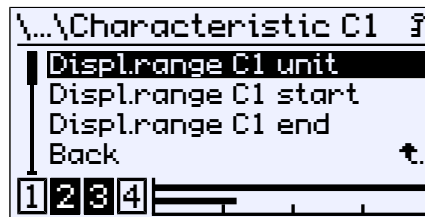

Fig. 83: Characteristic C1 (flow rate)

Menu name	Description
Displ.range C1 unit	This parameter is used to define the flow rate unit. It must have a length of at least 5 characters.
Displ.range C1 start	The start of the display range is defined with this parameter.
Displ.range C1 end	The end of the display range is defined with this parameter.
Back	↵ This represents the output (exit) of the menu. Press 'back' to return to the Channel 1 menu.

This function allow the flow rate to be measured by means of an effective pressure procedure on a measuring panel. The differential pressure is a measure for the flow rate:

$$q = \sqrt{\Delta p}$$

q: Flow rate
Δp: Differential pressure

The root extracted input signal is shown as a signal from 0 ... 100 %. The display value can be furnished with a different unit with the parameter **Displ.range C1 unit**. The display range can be scaled to this unit with the parameters **Displ. C1 start** and **Displ.range C1 end**.

5.4.1.3.2 Characteristic C1 (Table)

Path: \Configuration\Channel 1\Characteristic C1
Level: 3

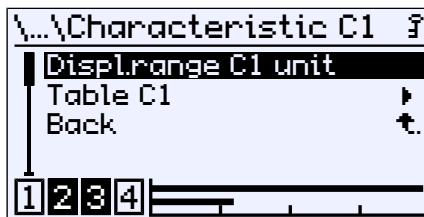

Fig. 84: Characteristic C1 (table)

Menu name	Description
Displ.range C1 unit	A unit for the display value is defined with this parameter. It must have a length of at least 5 characters.
Table C1	▶ The table is defined in this menu.
Back	⏪ This represents the output (exit) of the menu. It is used to return to the Channel 1 menu.

The table function can be used to correct the input characteristic of the sensor at any point. The changes impact on the display value and the output signal.

5.4.1.3.2.1 Table C1

Path: \Configuration\Channel 1\Characteristic C1\Table C1
Level: 4

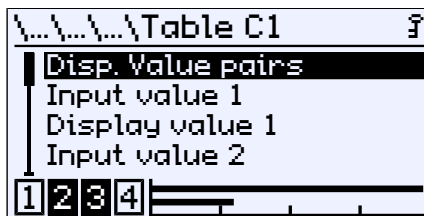

Fig. 85: Table C1

Menu name	Description
No. Value pairs	This parameter is used to define the number of value pairs. Value range: ... 2 ... 30
Input value 1	Value pair 1
Display value 1	
Input value 2	Value pair 2
Display value 2	
⋮	
Input value 30	Value pair 30
Display value 30	
Back	⏪ This represents the output (exit) of the menu. Press 'back' to return to the Characteristic C1 menu.

Each support point is stated by a value pair comprising the **Input value** x and **Display value** x . The index x states the number of the value pair. At least two value pairs always need to be stated. The maximum number of value pairs is 30.

The first value pair is assigned to the start of the measuring range and the last value pair to the end of the measuring range. There is a linear interpolation of the characteristic between two values. The input values must either be continuously rising or falling. This is not mandatory for the assigned display values.

For example:

The table should have 7 value pairs ⁽⁴⁾. Of the input signal, the range 20 ... 80 Pa should be used. The basic measuring range is 0 ... 100 Pa. The display should display in the start of the measuring range 20 Pa and at the end of the measuring range 80 Pa.

Basic measuring range 0...100 Pa
 Measuring range 20 ... 80 Pa
 Display range 10 ... 70 Pa
 Output signal 0...20 mA

The value point 5 should be displayed so that the output delivers 12 mA. The following values are then entered in the menu **Table C1** :

Input	E1	O2	O3	O4	O5	O5	O6	O7
Value [Pa]	20	30	40	50	60	56	70	80
Display	A1	A2	A3	A4	A5	A5	A6	A7
Value [Pa]	10	20	30	40	50	46	60	70
Output [mA]	0	3.33	6.66	10	13.33	12	16.66	20

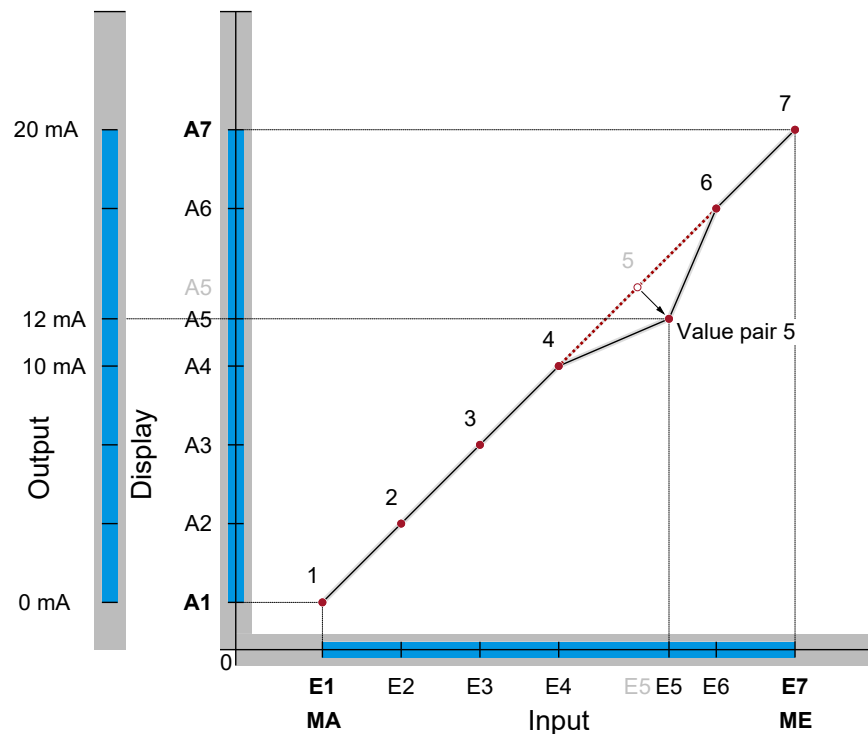

Fig. 86: Table function

⁽⁴⁾input values are abbreviated with E1...E7 and display values with A1...A7

5.4.1.3.3 Characteristic C1 (volume flow)

Path: \Configuration\Channel 1\Characteristic C1
Level: 3

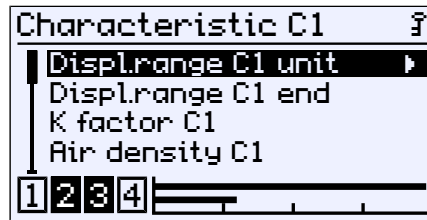

Fig. 87: Characteristic C1 (volume flow)

Menu name	Description
Displ.range C1 unit	This parameter can be used to set a unit for the display.
Displ.range C1 end	The end of the display range is defined with this parameter.
K factor C1	This parameter is used to enter the specific calibration factor for the panel type.
Air density C1	This parameter can be used to enter the air density at operating temperature.
Formula C1	The calculation formula is selected in this menu.
Back	This represents the output (exit) of the menu. It is used to return to the Channel 1 menu.

This function allow the volume flow to be measured by means of an effective pressure procedure.

$$q = k \cdot \sqrt{\Delta p}$$

q: Volume flow
k: K factor
Δp: Differential pressure

Fig. 88: Volume flow basic formula

The ventilator is equipped with a measuring device to measure the volume flow. Each manufacturer states a K factor for his ventilator. This is filed with the parameter **K factor C1**.

The calculation formula of the manufacturer can deviate from the basic formula. Therefore the manufacturer of the ventilator used in the menu **Formula C1** must be selected.

Due to the fact that the volume of a gas changes with the pressure and the temperature, the air pressure at operating temperature is taken into account in the calculation. The value can be entered with the parameter **Air density C1**. As standard, the density is preset with 1.2040 kg/m³.⁽⁵⁾

⁽⁵⁾ This value corresponds to the air density at 20 °C as sea level at an atmospheric pressure of 1013.25 hPa and dry air



NOTICE

The device always calculates the volume flow in the unit Pa.

If the formulae are recalculated, the following must be taken into account:

1. If the device has been calibrated in the unit Pa, the measured value can simply be inserted into the relevant formula.
2. If the device is working in a different unit, the measured value must first be converted into the unit Pa before the formula can be used.

5.4.1.3.3.1 Display range C1 unit

Path: \Configuration\Channel 1\Characteristic C1\Displ.range C1 unit
Level: 4

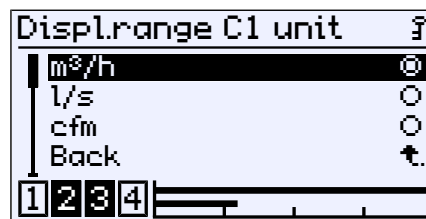

Fig. 89: Display range C1 unit

The following units are available for selection:

m ³ /h	Cubic metre per hour	Default value
l/s	Litre per second	
cfm	Cubic feet per minute	

5.4.1.3.3.2 Formula C1

Path: \Configuration\Channel 1\Characteristic C1\Formula C1
 Level: 4

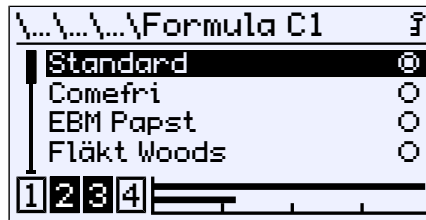

Fig. 90: Formula C1

The following table lists the formulas specified by the respective manufacturer for calculating the volume flow.

Standard EBM Pabst Goal Abegg SIEGLE+EPPLE	$q = k \cdot \sqrt{\Delta p}$
Comefri Nicotra Gebhardt Rosenberg	$q = k \cdot \sqrt{\frac{2}{\rho} \cdot \Delta p}$
Fläkt Woods	$q = \frac{1}{k} \cdot \sqrt{\Delta p}$

Fig. 91: Volumetric flow measurement Manufacturer's formulas

Volume flow measurement at the inlet cone

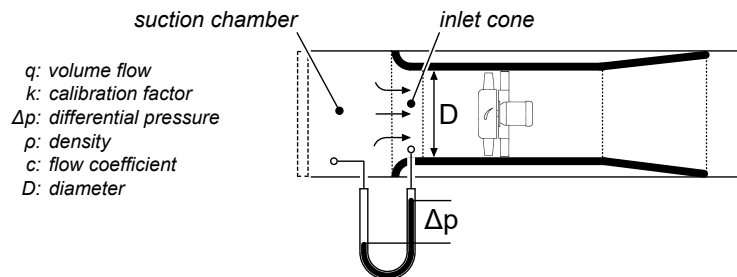

basic formula $q = c \cdot \frac{\pi}{4} \cdot D^2 \cdot \sqrt{\frac{2}{\rho} \cdot \Delta p}$

Fig. 92: Volume flow measurement

Fans are usually equipped with an inlet cone. The volume flow measurement consists of one or more measuring points in the inlet cone and one measuring point in the suction chamber of the ventilation unit. The differential pressure between the measuring points is used to calculate the volume flow.

The basic formula given applies to a frictionless and loss-free flow with constant density. In reality, therefore, a correction value caused by the design and other factors must be taken into account.

The fan manufacturers have determined the correction value for each inlet nozzle. In general, these values are called calibration factor or K-factor and can be found in the data sheet or operating instructions of the volume flow measuring device.

5.4.1.3.4 Characteristic C1 (linear function)

Path: \Configuration\Channel 1\Characteristic C1
Level: 3

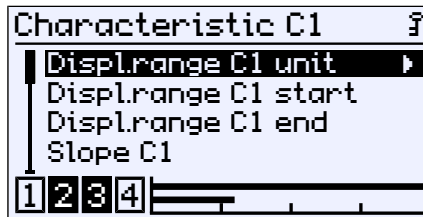

Fig. 93: Characteristic curve C1 (linear function)

Menu name	Description
Displ.range C1 unit	This parameter defines the unit of the flow measurement. A maximum of 5 characters can be used.
Displ.range C1 start	This parameter defines the beginning of the display range.
Displ.range C1 end	This parameter defines the end of the display range.
Slope C1	This parameter determines the slope (m) of the linear characteristic.
Offset C1	This parameter defines the axis section (b) of the linear characteristic.
Back	⬅ This represents the output (exit) of the menu. This takes you back to the Channel 1 menu.

With this menu, the output characteristic can be parameterized as a linear function.

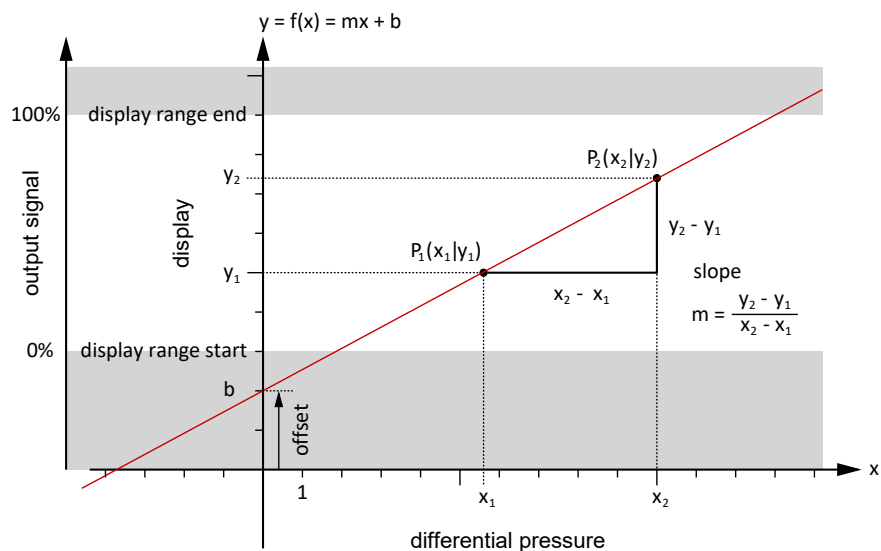

Fig. 94: Linear function

5.4.1.4 Number format C1

Path: \Configuration\Channel 1\Number format C1

Level: 3

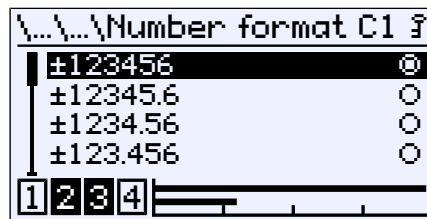

Fig. 95: Number format C1

The number of decimal places can be determined with this menu. All theoretically possible variants are made available for selection.

The decimal places are limited by the measuring range. There are 8 characters available with signs, decimal points and number value. The measuring data display can have less decimal points than set in the number format.

For example:

Set number format: ±123.456

Current measuring value: -1234.567

Displayed measuring value: -1234.57

Only two decimal points are shown, as otherwise the maximum number of 8 characters would be exceeded. The last decimal place is rounded.

5.4.1.5 Colour change C1

Path: \Configuration\Channel 1\Colour change C1
Level: 3

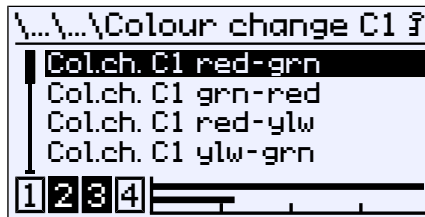

Fig. 96: Colour change C1

This menu is used to set the switch threshold for the colour change of the back lighting. A pre-requisite for the efficiency of the switch thresholds is the activation of the colour change in the menu LCD colour [▶ 100] and its assignment to measuring channel K1 in the menu Col.ch. assignment [▶ 99].

Menu name	Description
Col.ch. C1 red-grn	Switching thresholds for the named colour change
Col.ch. C1 grn-red	
Col.ch. C1 red-ylw	
Col.ch. C1 ylw-grn	
Col.ch. C1 grn-ylw	
Col.ch. C1 ylw-red	
Col.ch. C1 hyst..	This parameter can be used to set an hysteresis for all switch thresholds.
Col.ch. C1 delay on	This parameter can be used to set an activation delay for all switch thresholds.
Col.ch. C1 delay off	This parameter can be used to set a deactivation hysteresis for all switch thresholds.
Back	⬅ This represents the output (exit) of the menu. Press 'back' to return to the Channel 1 menu.

There are precisely two types of colour change that can be set in the menu LCD colour . Depending on this, certain thresholds are ignored. So, for instance, the switching threshold Col.ch. C1 ylw-grn is not relevant for the colour change type red/green.

By means of colour changes, it is possible to signalise certain operating states by the colour of the back lighting.

5.4.1.5.1 Colour change C1 type: red/green

The following switching thresholds are relevant for this colour change:

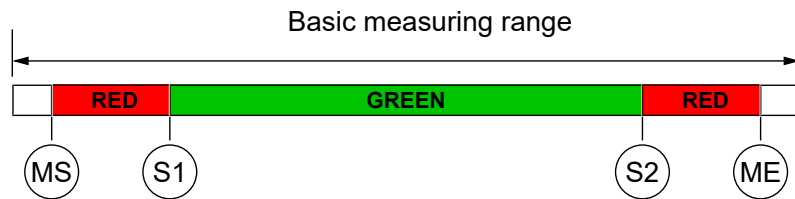

Fig. 97: Colour change red/green

MS	Meas.range C1 start	See menu Measurement C1 : [58]
S1	Col.ch. C1 red-grn	
S2	Col.ch. C1 grn-red	
ME	Meas.range C1 end	See menu Measurement C1 : [58]

For example:

Input of the threshold red/green

Path: \Configuration\Channel 1\Colour change C1\Col.ch. C1 red-grn
Level: 4

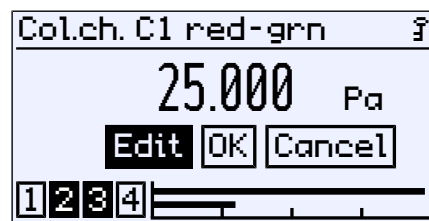

Fig. 98: Colour change C1 red-green

The other switch thresholds are entered in the same way.

5.4.1.5.2 Colour-change C1 type: red/yellow/green

The following switching thresholds are relevant for this colour change:

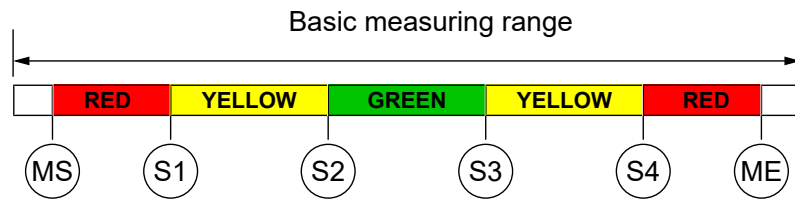

Fig. 99: Colour change red/yellow/green

MS	Meas.range C1 start	See menu Measurement C1 : [▶ 58]
S1	Col.ch. C1 red-ylw	
S2	Col.ch. C1 ylw-grn	
S3	Col.ch. C1 grn/ylw	
S4	Col.ch. C1 ylw/red	
ME	Meas.range C1 end	See menu Measurement C1 : [▶ 58]

For example:

Channel 1: Basic measuring range: 0 ... 100 Pa

The measuring range is defined as 10 ... 90 Pa. The green range should be 0 ... 60 Pa. Then the critical range (yellow) up to 70 Pa starts. This is where the red range that ranges up to the measuring range end at 90 Pa starts. The lower colour changes red-yellow and yellow-green are switched off.

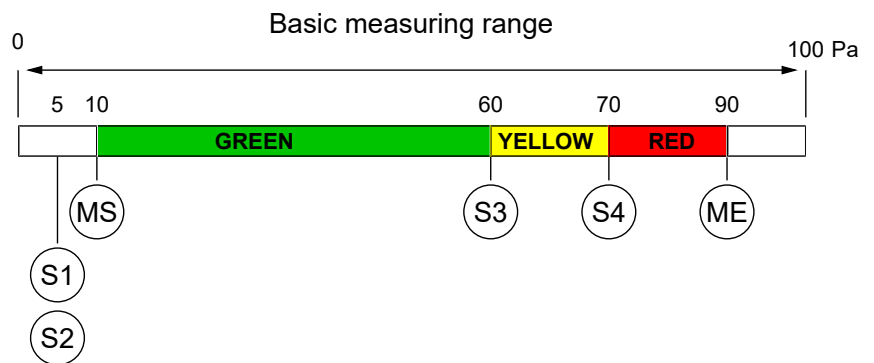

Fig. 100: Example colour-change red/yellow/green

MS	Meas.range C1 start	10 Pa	
S1	Col.ch. C1 red-ylw	5 Pa	< MS
S2	Col.ch. C1 ylw-grn	5 Pa	< MS
S3	Col.ch. C1 grn/ylw	60 Pa	
S4	Col.ch. C1 ylw/red	70 Pa	
ME	Ms.range C1 end	90 Pa	

The lower colour changes S1 and S2 are 'switched off' by placing thresholds outside the measuring range. If the threshold values were to be laid precisely at the start of the measuring range, the display would shine red in the zero-point,

Red > Yellow > Green

The cause for this lies in the priority of the colours. The red colour has priority over the yellow colour and this has priority over the green colour.

5.4.1.5.3 Colour change C1 hysteresis

Path: \Configuration\Channel 1\Colour change C1\Col.ch. C1 hyst.
Level: 4



Fig. 101: Colour change C1 hyst.

This parameter can be used to define an hysteresis for the switch thresholds of the colour change. The set hysteresis applies to all switch thresholds at the same time. The input is a pressure value in the current unit. The allowed value range is stated automatically.

Functional principle:

The colour symbolises the following risk levels:

Colour	Risk level	Operating mode
Green	0	Normal
yellow	1	Warning
rot	2	Danger

The following colour change red/yellow/green is examined as an example for all colour changes. There are a total of four switch thresholds (S1...S4) in which a colour change is realised. This leads to the following image without hysteresis.

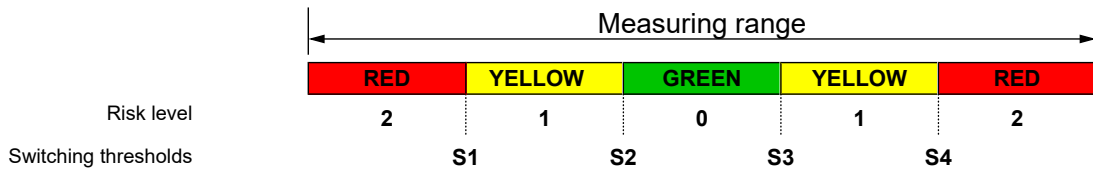

Fig. 102: Colour change (without hysteresis)

The parameter `Col.ch. C1 hyst.` defines a distance to the switch threshold. The colour change with hysteresis is then realised as follows:

(i) Lower switching thresholds S1 and S2

In case of a colour change from a higher to a lower risk level, the hysteresis acts with an increasing signal.

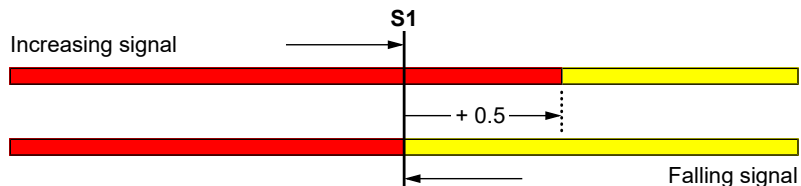

Fig. 103: Example: Hysteresis S1

(ii) Upper switching thresholds S3 and S4

In case of a colour change from a lower to a higher risk level, the hysteresis acts with an decreasing signal.

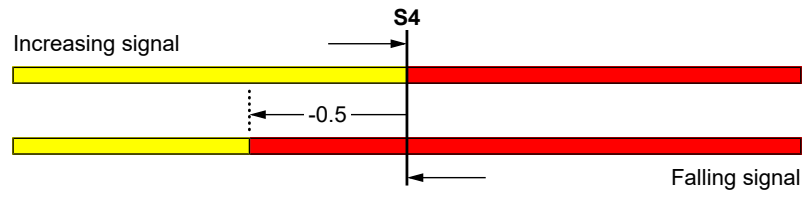

Fig. 104: Example: Hysteresis S4

5.4.1.5.4 Colour change C1 delay on

Path: \Configuration\Channel 1\Colour change C1\Col.ch. C1 delay on Level: 4:

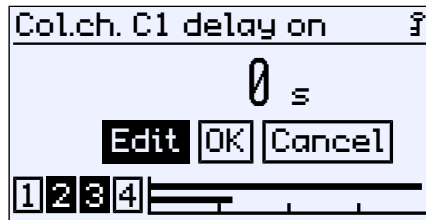

Fig. 105: Colour change C1 delay on

The activation delay acts when changing from a lower risk level to a higher risk level.

5.4.1.5.5 Colour change C1 delay off

Path: \Configuration\Channel 1\Colour change C1\Col.ch. C1 delay off Level: 4

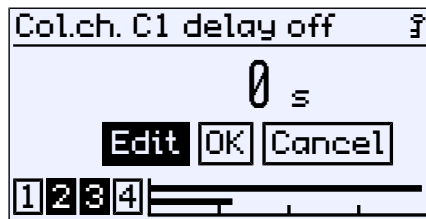

Fig. 106: Colour change C1 delay off

The deactivation delay acts when changing from a higher risk level to a lower risk level.

This results in the following connection between the delay and the colour change:

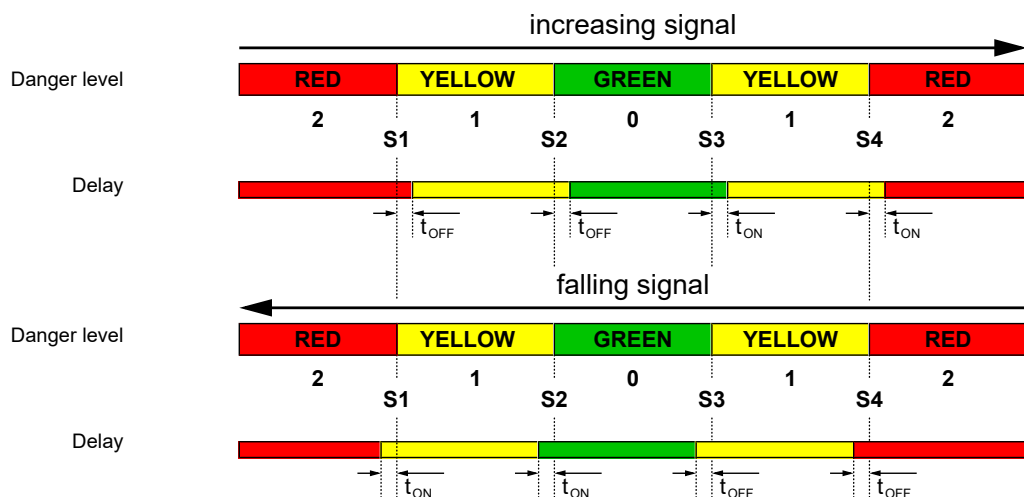

Fig. 107: Colour change delay

5.4.2 Channel 2

Path: \Configuration\Channel 2
Level: 2

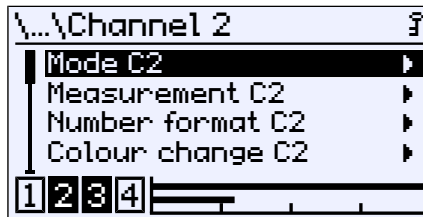

Fig. 108: Channel 2

The 2nd measuring channel is configured identically to the 1st measuring channel [▶ 56]. No explanation is provided at this point.

5.4.3 Channel 3

Path: \Configuration\Channel 3
Level: 2

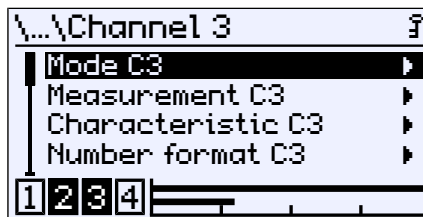

Fig. 109: Channel 3

The third channel is a 'virtual' channel, which is calculated from the two input channels 1 and 2 using a mathematical function.

Menu expansion

Menu name	Description
Mode C3	▶ With this menu you can select fixed functions for the measuring channel.
Measurement C3	▶ In this menu the input of the measuring channel is parameterized.
Characteristic C3	▶ This menu is hidden depending on the selected mode.
Number format C3	▶ In this menu, the decimal places for the measured value display of the measuring channel are set.
Colour change C3	▶ In this menu the colour changes for the measuring channel are parameterized.
Back	⬅ This represents the output (exit) of the menu. This takes you 'Back' to the configuration menu.



Signpost [▶ Page]

- Mode C3 [▶ 78]
- Measurement C3 [▶ 79]
- Characteristic C3 [▶ 81]
- Number format C3 [▶ 89]
- Colour change C3 [▶ 90]

5.4.3.1 Mode C3

Path: \Configuration\Channel 3\Mode C3

Level: 3

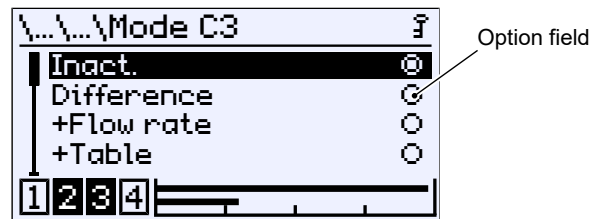

Fig. 110: Mode C3

Parameter value	Description
Inact.	<input checked="" type="radio"/> Activates/deactivates Channel 3
Difference	<input type="radio"/> Difference of the input channels
+Flow rate	<input type="radio"/> Difference of the input channels with subsequent root extraction for flow measurement
+Table	<input type="radio"/> Difference of the input channels with subsequent characteristic curve correction by means of a piece point table.
Dyn. filter monitor.	<input type="radio"/> Monitoring of filters in ventilation systems
Back	<input type="radio"/> This is the menu exit point. It takes you 'Back' to the Channel 3 menu.

The operating modes **+Flow rate**, **+Table** and **Dyn. filter monitor** . require a different configuration of the characteristic. Consequently, the calling menu after the exit has the menu expansion **Characteristic C3** , which enables the configuration of the characteristic for the selected mode.

Additional settings are made in the menu **Measurement C3** for the operating modes **Difference**, **+Flow rate**, **+Table** .

See also

📖 Characteristic C3 (menu expansion) [▶ 81]

5.4.3.2 Measurement C3

Path: \Configuration\Channel 3\Measurement C3

Level: 3

The menu changes depending on the set operating mode of the measuring channel.

Mode = Difference, +Flow rate, +Table

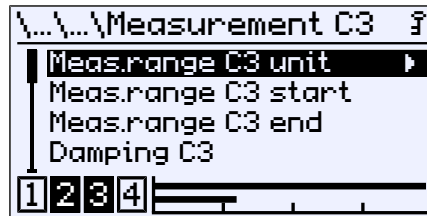

Fig. 111: Measurement C3 (difference +flow +table)

Menu name		Description
Meas. range C3 unit	▶	This parameter is used to define the measuring range unit.
Meas. range C3 start		The start of the measuring range is defined with this parameter.
Meas. range C3 end		The end of the measuring range is defined with this parameter.
Damping C3		This parameter serves to dampen the display.
Offset C3		The characteristic is displaced with the parameter offset.
Zero-pt. window C3		The zero point window parameter defines a range around zero in which the display value is set to zero.
Limit C3	<input type="checkbox"/>	This property determines whether or not the set measuring range limits act on the meas.data display.
Formula C3	▶	A formula for calculating the difference between the input channels is defined in this menu.
Back	⬅	This is the menu exit point. Press 'Back' to return to the Channel 3 menu

An explanation of most of the parameters can be found in the description of the first channel (see Measurement C1 [p. 58]).

Mode = Dyn. filter monitoring

Fig. 112: Measurement C3 (Dynamic filter monitoring)

Menu name	Description
Limit C3	<input type="checkbox"/> This property determines whether the measured values are limited to the set limits.
Back	t. This is the menu exit point. Press 'Back' to return to the Channel 3 menu

The limits of the display values are set in the menu **Characteristic C3** .

5.4.3.2.1 Formula C3

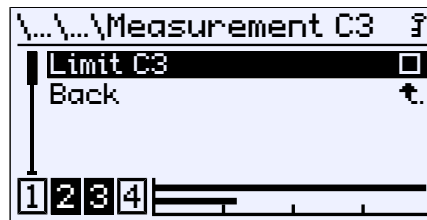
Path: \Configuration\Channel 3\Measurement C3\Formula C3
Level: 4

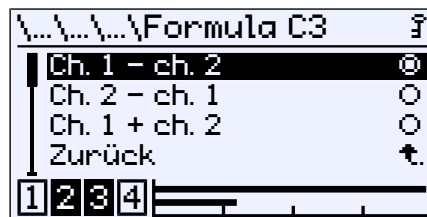

Fig. 113: Formula C3

Menu name	Description
Ch. 1 - ch. 2	<input type="radio"/> Formula for calculating the difference or sum.
Ch. 2 - ch. 1	<input type="radio"/>
Ch. 1 + ch. 2	<input type="radio"/>
Back	t. This is the menu exit point. Press 'Back' to return to the Channel 3 menu

The setting made affects the operating modes Difference, +Flow rate and +T-able.

5.4.3.3 Characteristic C3 (menu expansion)

The menu changes depending on the set operating mode of the measuring channel.

5.4.3.3.1 Characteristic C3 (+flow rate)

Path: \Configuration\Channel 3\Characteristic C3
Level: 3

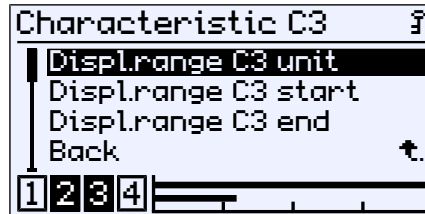

Fig. 114: Characteristic C3 (+flow rate)

Menu name	Description
Displ.range C3 unit	This parameter is used to define the display range unit.
Displ.range C3 start	The start of the display range is defined with this parameter.
Displ.range C3 end	The end of the display range is defined with this parameter.
Back	↔ This is the menu exit point. It is used to return to the Channel 3 menu.

5.4.3.3.2 Characteristic C3 (+table)

Path: \Configuration\Channel 3\Characteristic C3

Level: 3



Fig. 115: Characteristic C3 (+table)

Menu name	Description
Display C3 unit	This parameter is used to define the unit for channel 3.
Table C3	▶ This menu is used to define a support point table for Characteristic C3.
Back	◀ This is the menu exit point. It is used to return to the Channel 3 menu.

A description of how to create such a support point table can be found in the section Table C1 [▶ 64].

5.4.3.3.3 Characteristic C3 (dynamic filter monitoring)

Path: \Configuration\channel 3\characteristic curve C3
Level: 3

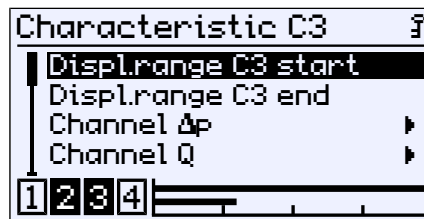

Fig. 116: Characteristic C3 (dyn. filter monitoring)

Menu name	Discription
Display C3 start	The display start is defined with this parameter.
Displ. C3 end	The display end is defined with this parameter.
Channel Δp	▶ This parameter defines the channel for the differential pressure measurement across the filter.
Channel Q	▶ This parameter defines the channel for the volume flow measurement.
Approximation	▶ This parameter is used to define the approximation formula for the volume flow measurement.
Δp clean	This parameter defines the limit value for the clean filter.
Δp soiled	This parameter defines the limit value for the contaminated filter.
Δp Correction value	This parameter can be used to set an offset for the characteristic curve.
Max. volume flow	This parameter defines the upper limit for the volume flow.
Min. volume flow	This parameter determines the lower limit for the volume flow. The measured value is set to 0% if the volume flow falls below the limit value.
Table	▶ In this menu, a calibration table can be created to adapt to the filter type.
Min. soiling	This parameter specifies a degree of pollution below which the calculated degree of contamination is set to 0%. (Zero point window without linear approximation).
Damping C3	This parameter lessens the degree of contamination.
Back	⬅ This is the menu exit point. It is used to return to the Channel 3 menu.

5.4.3.3.1 Min. volume flow

Path: \Configuration\channel 3\characteristic C3\min. volume flow
level: 4

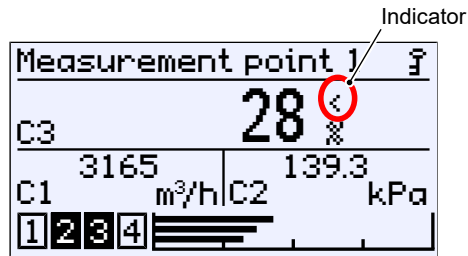

Fig. 117: Zero point window degree of contamination

A lower limit for filter monitoring is defined with the **min. volume flow** parameter. The degree of contamination measured value is frozen as soon as the volume flow falls below this limit. This condition is indicated on the display by the sign < next to the degree of contamination measured value.

5.4.3.3.2 Calibration table

Path: \Configuration\channel 3\characteristic curve C3\table
level: 4

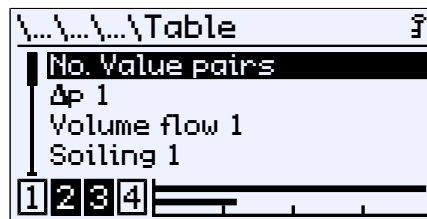

Fig. 118: Table (dyn. filter monitoring)

The degree of contamination is corrected using the table if the **No. Value pairs** in the table is ≥ 2 .

Menu name	Discription
No. Value pairs	This parameter is used to define the number of value pairs. Up to max 10 value pairs can be used.
$\Delta p1$	Measured value filter differential pressure 1
Volume flow 1	Measured value volume flow 1
Soiling 1	Measured value degree of contamination 1
$\Delta p2$	Measured value filter differential pressure 2
Volume flow 2	Measured value volume flow 2
Soiling 2	Measured value degree of contamination 2
...	
$\Delta p10$	Measured value filter differential pressure 10
Volume flow 10	Measured value volume flow 10
Soiling 10	Measured value degree of contamination 10

The table values must be entered with increasing volume flow.

5.4.3.3.3 Explanations for dynamic filter monitoring

5.4.3.3.3.1 General

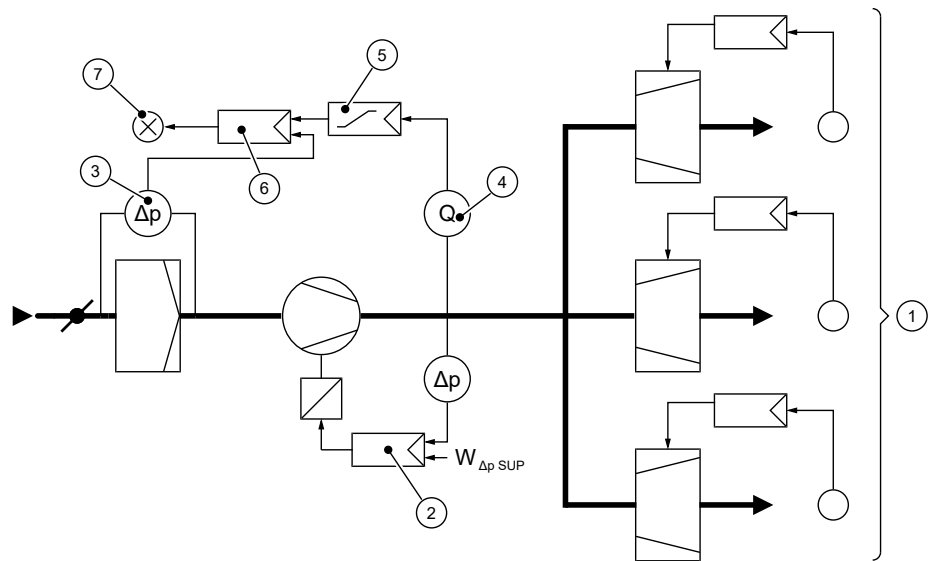

Fig. 119: Principal schema filter monitoring

1	Zones with variable supply air volume flow
2	Supply air pressure control with ventilator speed control
3	Filter monitoring differential pressure sensor (channel Δp)
4	Volume flow controller (channel Q)
5	Target value guide encoder
6	Difference pressure controller of the filter monitoring
7	Air filter - fault message

The air filter in this example has the task of retaining dust-like soiling from the outside air. As contamination increases, differential pressure measured above the filter increases. As soon as the differential pressure exceeds the set limit, the filter sensor reports that the filter is contaminated. This is shown as a malfunction.

Volume flow control keeps the air volume flow constant despite an increase in contamination by raising the ventilator speed. The pressure drop above the air filter does not, however, just depend on the degree of contamination, but also the volume flow.

The pressure drop changes in square to the volume flow. Therefore, a reduction of the volume flow from 100 % to 50 % means a reduction of the pressure loss above the filter element from 100 % to 25 %.

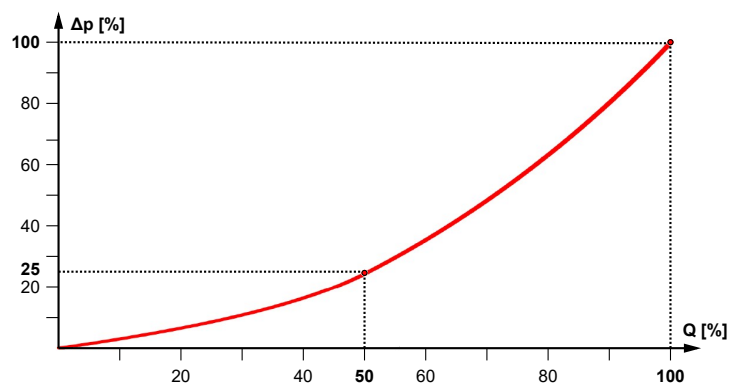

Fig. 120: General filter characteristic

To determine the degree of contamination using differential pressure measurement, with conventional methods it is necessary to carry out the measurement at maximum volume flow. This measurement is typically performed at regularly repeated intervals.

5.4.3.3.3.2 Determining system-specific parameters

Measuring filter contamination without having to set the volume flow to 100% is exactly what the “Dynamic filter monitoring” function allows you to do.

For this purpose, the device must be configured for the respective filter types by measuring the characteristic filter curve and storing it as a table.

For the measurement, the differential pressure is set in relation to the filter (channel 1) and volume flow (channel 2). In this way, the device can mathematically compensate for nonlinear influences.

5.4.3.3.3.3 Calibration to the filter type

In contrast to a linear or square root filter characteristic, the calibration achieves a much more accurate measurement. Typical measurement deviation can then be calculated as +/- 5%.

The zero point window should only be as large as necessary, otherwise the measured value can be distorted with small volume flows and a clean filter.

See also

 Measurement C1 [[▶ 58](#)]

Differential pressure measurement [channel 1]

- The differential pressure at the nominal volume flow must first be determined from the filter data. The measuring range of channel 1 is large enough to measure this pressure safely.
- Offset and zero point windows remain at 0 so the calibration is not affected.
- Select the damping so large that the measured value is sufficiently steady.
- Channel 1 and 2 damping should be chosen to be the same.

Channel 1 is configured as follows:

Mode C1:	Linear
Number format:	+/- 12345.6 (Pa, 1 decimal place)
Measuring range C1 unit:	Pa
Measuring range C1 start:	0 Pa
Measuring range C1 end:	e.g. 500 Pa
Offset C1:	0 Pa
Zero point window C1:	0 Pa
Damping C1:	e.g. 10 s (equal to damping K2)

Volume flow measurement [channel 2]

- Channel 2 is configured either as a volume flow or flow measurement. Both options are equivalent and differ only in the parameters to be entered:

Volume flow measurement: K factor and end of measuring range

Flow measurement: Differential pressure and display range

- Differential pressure at the nominal volume flow can be taken from the characteristic data of the fan and entered as “**Meas.range C2 end**”. For the specification, the volume flow per fan is decisive rather than the sum of all fans.
- Offset and zero window remain at 0 so that calibration is not affected.

- Choose the damping so large that the measured value is calm enough.
- Channel 1 and 2 damping should be chosen to be the same.
- "Formula C2" must be set according to the manufacturer's instructions.

Channel 2 is configured as follows:

Mode C2:	Volume flow
Number format C2:	+/-123456
Formula C2:	e.g. default
Displ.range C2 end:	e.g. 25000 m ³ /h
K factor C2:	e.g. 1055
Air density:	1.20 kg/m ³
Display unit:	m ³ /h
Meas.range C2 unit:	Pa
Meas.range C2 start:	0 Pa
Meas.range C2 end:	e.g. 561 Pa
Offset:	0 Pa

Virtual channel [channel 3]

- Pressure drop at the nominal volume flow for the clean and dirty filter can be taken from the filter data and entered as parameters "dp clean" and "dp soiled".
- The "Max. volume flow" is set equal to the Q_{fan} , the nominal filter volume flow.

Please observe the following:

Systems with several fans must be dimensioned so that each fan contributes the same share to the total volume flow:

$$Q_{fan} = Q_{total} / \text{number of fans}$$

Channel 3 is configured as follows:

Mode C3:	Dyn. filter monitoring
Number format:	+/-12345.6 (display in 0.1%)
Display C3 start	0 %
Display C3 end:	100 %
Channel dp:	Channel 1
Channel Q:	Channel 2
Approximation:	Linear
dp clean:	e.g. 68 Pa
dp soiled:	e.g. 168 Pa
dp correction value:	0 Pa
Max. volume flow:	e.g. 20000 m ³ /h
Min. volume flow:	0 m ³ /h
Display of the C3 value pairs:	0
Min. contamination:	0 %

5.4.3.3.3.4 Calibration

In practice, the relationship between the differential pressure across the filter element and volume flow is often more complex than can be adequately described with a linear approximation.

This is the exact reason for the option of adapting the device to the filter type with a table-based calibration.

Measurement recording

After the Calibration to the filter type [▶ 86] the filter is attached for calibration to simulate an average contamination of approx. 70%.

Volume flow is then reduced in stages from the nominal volume flow and the measured values shown on the display are documented: Volume flow, differential pressure, degree of contamination.

Optionally, the fan control frequency should be logged in order to approach the same measuring points in the event of any subsequent measurements that may be necessary.

It is important that measurements are taken at nominal and minimum volume flow.

For example:

Number of value pairs = 7; this creates the following table:

Value pair	Volume flow	Differential pressure	Degree of contamination	Frequency
	[m³/h]	[Pa]	[%]	[Hz]
7	20000	Measured value 7	Measured value 7	Setting 7
6	17500	Measured value 6	Measured value 6	Setting 6
5	15000	Measured value 5	Measured value 5	Setting 5
4	12500	Measured value 4	Measured value 4	Setting 4
3	10000	Measured value 3	Measured value 3	Setting 3
2	7500	Measured value 2	Measured value 2	Setting 2
1	5000	Measured value 1	Measured value 1	Setting 1

Table

For the compensation, the filter characteristic must first be determined with varying volume flow. Values can be read from the display and entered into the table. As soon as two or more lines are entered in the table, the calculated degree of contamination is corrected again using the characteristic curve stored in the table.

The number of value pairs (e.g. 7) is entered in “Disp. value pairs”.

The table must be sorted, entered by ascending volume flow:

Δp 1	Measured value 1
Volume flow 1	5000
Contamination 1	Measured value 1
Δp 2	Measured value 2
Volume flow 2	7500
Contamination 2	Measured value 2
...	
Δp 7	Measured value 7
Volume flow 7	20000
Contamination 7	Measured value 7

5.4.3.3.3.5 Optimisation

After the calibration has been completed, configuration can still be optimised:

Channel 1:	Zero point window K1:	approx. 3 - 4 Pa
	Number format K1:	+/- 123456
Channel 2:	Zero point window K1:	approx. 5 Pa
Channel 3:	Min. volume flow:	approx. 4000 m3/h
	Min. contamination:	approx. 20%
	Number format K3:	+/- 123456

5.4.3.4 Number format C3

Path: \Configuration\Channel 3\Number format C3
 Level: 3

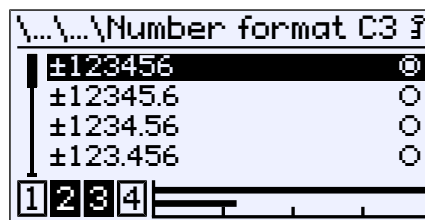

Fig. 121: Number format C3

With this menu the number of decimal places can be determined. All theoretically possible variants are available.

The decimal places are limited by the measuring range. 8 characters are available with sign, decimal point and numerical value. The measured value display can have fewer decimal places than the number format.

Example:

Set number format: ±123.456
 Current measuring value: -1234.567
 Displayed measuring value: -1234.57

Only two decimal places are displayed, otherwise the maximum number of 8 characters would be exceeded. The last digit is rounded.

5.4.3.5 Colour change C3

Path: \Configuration\Channel 3\Colour change C3

Level: 3



Fig. 122: Colour change C3

This menu is used to set the switching thresholds for the colour change of the backlight. A prerequisite for the effectiveness of the switching thresholds is the activation of the colour change in the **LCD colour** menu and its assignment to the measuring channel in the **Col.ch. assignment** menu.

For a detailed explanation of the colour changes, refer to the description of channel 1.

See also

- 📄 LCD colour [▶ 100]
- 📄 Colour change assignment [▶ 99]
- 📄 Colour change C1 [▶ 71]

5.4.4 Analog output

Path: \Configuration\Analog output
 Level: 2

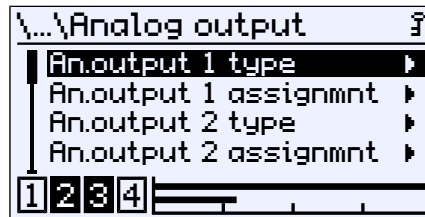

Fig. 123: Analog output

NOTICE! In devices with just one measuring channel, the parameters for the second output are not required.

Menu name	Description
An.output 1 type	This menu is used to define the output signal for output 1.
An.output 1 assignmnt	The measuring channel of output 1 is assigned in this menu.
Output 2 type	This menu is used to define the output signal for output 2.
An.output 2 assignmnt	The measuring channel of output 2 is assigned in this menu.
Limit I min.	Parameters for the lower limit of the current output.
Limit I max	Parameters for the upper limit of the current output.
I-error signal	Parameters for the error signal of the current output.
Limit U min.	Parameters for the lower limit of the voltage output.
Limit U max.	Parameters for the upper limit of the voltage output.
U error signal	Parameters for the error signal of the voltage output.
Back	This represents the output (exit) of the menu. Press 'back' to return to the configuration menu.

The parameters for the type and assignment work for both channels identically. Therefore, the parameters for channel 1 are explained as an example.

The same also applies for limit parameters that are explained for the current signal. If the signal type is changed, the parameters that need to be entered for the previous signal are retained.

5.4.4.1 Analog output 1 type

Path: \Configuration\Analog output\An.output 1 type
Level: 3

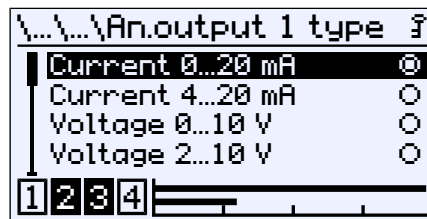

Fig. 124: Analog output 1 type

The signals can be set for output 1:

Current signals	Voltage signals
0 ... 20 mA	0 ... 10 V
4 ... 20 mA	2 ... 10 V
	1 ... 5 V

5.4.4.2 Analog output 1 assignment

Path: \Configuration\Analog output\An.output 1 assignmt
Level: 3



Fig. 125: Analog output 1 assignment

The assignment of the analogue outputs to the channels can be set freely. This menu item is not required for a device with just one channel.

5.4.4.3 Signal limits

NOTICE! The limit parameters apply for both output signals.

The output signal can be limited by the limit parameters. This primarily serves to prevent error messages in downstream systems caused by brief overstepping of measuring ranges. Due to the fact that the limit parameters for both signal types work the same way, they are only explained for the current signal at this point.

The parameters **Limit I min.**, **Limit I max.** and **I error signal** define the limits of the output signal that may not be undercut or exceeded regardless of the measured variable. These limit values take precedence over the **Meas.range C1 start** and **Meas.range C1 end** range defined by the parameter ⁽⁶⁾.

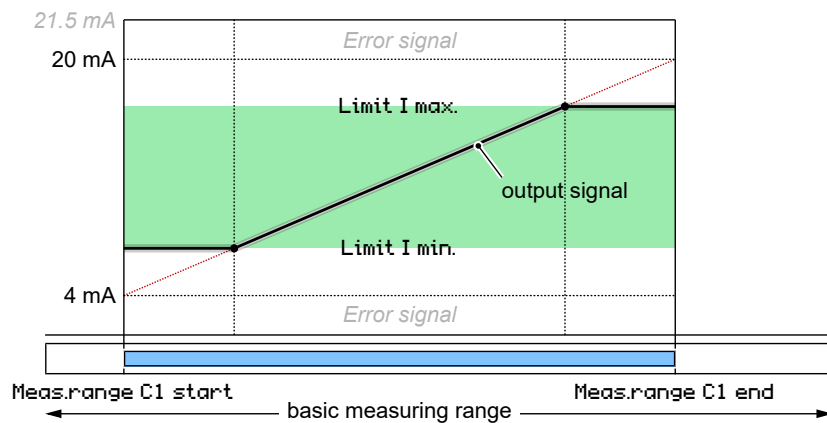

Fig. 126: Limitation of the output signal

The value defined via the parameter **I error signal** is issued if the device detects an internal error and can no longer work correctly. It should be noted here that not all potential errors and faults can be detected by the device itself.

Signal range

Current signal	0 ... 21.5 mA
Voltage signal	0 ... 10.5 V

⁽⁶⁾For the second channel, the channel number changes to C2.

5.4.5 Switch output

Path: \Configuration\Switch output

Level: 2

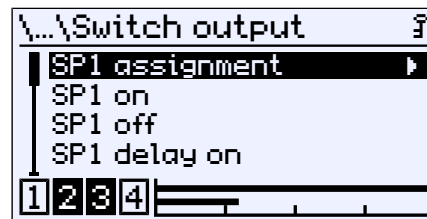

Fig. 127: Switch output

NOTICE! Depending on the model, the device has 2 or 4 switch outputs. As the configuration for each switch output is the same, only the parameters for the first switch output are shown.

Menu name	Description
SP1 assignment	This menu assigns the switch output 1 to channel or switches it off.
SP1 on	The activation point is set with this parameter.
SP1 off	The deactivation point is defined with this parameter.
SP1 delay on	The activation delay is defined with this parameter.
SP1 delay off	The deactivation delay is defined with this parameter.
SP1 function	The contact point is defined with this menu.
	⋮
Back	This represents the output (exit) of the menu. Press 'back' to return to the configuration menu.

5.4.5.1 SP1 assignment

Path: \Configuration\Switch output\SP1 assignment
Level: 3

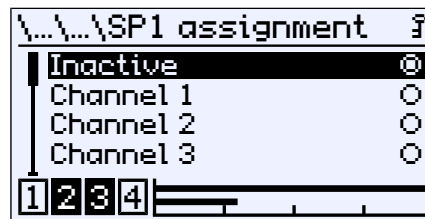

Fig. 128: SP1 assignment

This menu can be used to assign or deactivate the switch point of a channel.

5.4.5.2 SP1 function

Path: \Configuration\Switch output\SP1 function
Level: 3

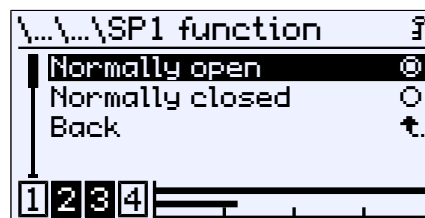

Fig. 129: SP1 function

The function of this contact is defined with this parameter.

5.4.5.3 Switching function

The function of the individual parameters is explained for all switch points using Switch point 1 as an example.

SP1 On defines the activation point, **SP1 Off** the deactivation point of switch output 1. The values are shown in the valid unit and set accordingly. The values are shown in the valid unit and set accordingly. Both parameters can be set independently over the entire value range.

If the parameter **SP1 on = SP1 off**, the contact pulls, if the measured value exceeds the parameter value. If the measured value undercuts the parameter value, the contact drops.

→ Increasing input signal
 ← dropping input signal

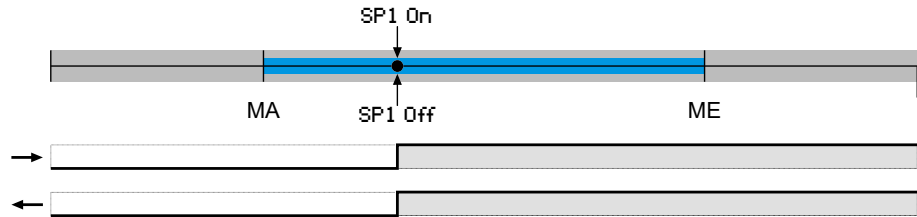

If the parameter **SP1 on > SP1 off**, the contact pulls, if the measured value exceeds the SP1 on. The contact only drops again if SP1 Off is undercut.

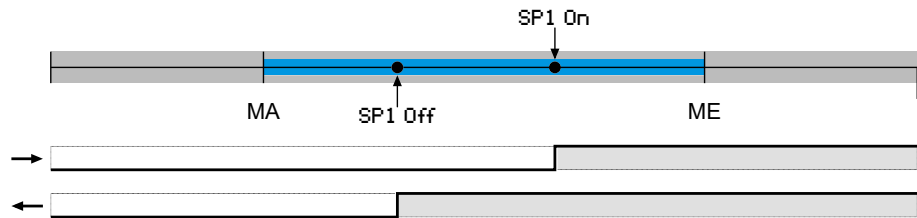

If the parameter **SP1 on < SP1 off**, the contact pulls, if the measured value lies between the parameter values:

$SP1\ on < \text{Measured value} < SP1\ off$. Otherwise the contact will drop.

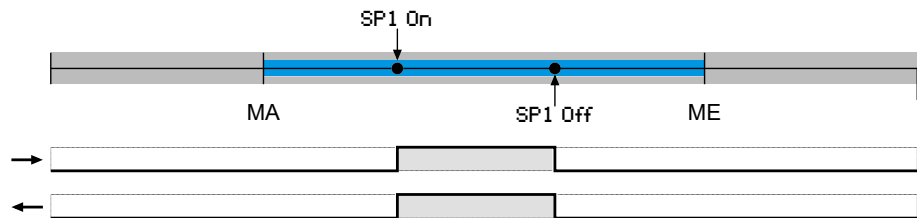

Fig. 130: Switch point setting

Delay

The switching behaviour of the contact can be delayed with the two parameters **SP1 delay on** and **SP1 delay off**.

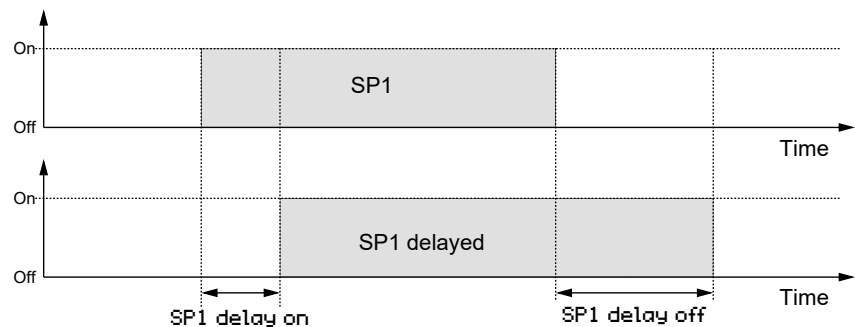

Fig. 131: Delay

5.4.6 Display

Path: \Configuration\Display
 Level: 2

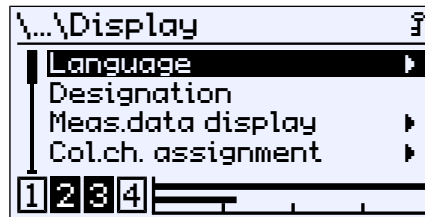

Fig. 132: Display

Menu name	Description
Language	The menu language can be selected in this menu.
Designation	This parameter can be used to file the designation for the device.
Meas.data display	This menu can be used to define which measuring value channel should be displayed.
Col.ch. assignmt	This menu can be used to determine which measuring channel controls the colour change.
LCD col.	This menu is used to determine the colour of the backlighting and/or their colour change.
LCD lighting	This parameter can be used to switch off the lighting based on a timer.
LCD contr.	This parameter is used to set the contrast for the LC display.
Back	This represents the output (exit) of the menu. Press 'back' to return to the configuration menu.

5.4.6.1 Language

Path: \Configuration\Display\Language

Level: 3



Fig. 133: Language

Parameter name	Language	
German	DE	German language
English	EN	English language
Español	ES	Spanish language
Français	FR	French language
Italiano	IT	Italian language
Magyar	HU	Hungarian language

5.4.6.2 Designation

Path: \Configuration\Display\Designation

Level: 3



Fig. 134: Designation

At this point, a designation for the differential pressure transmitter can be issued. There are 20 digits available. The designation appears on the measured value display.

5.4.6.3 Measuring data display

Path: \Configuration\Display\Meas.data display

Level: 3

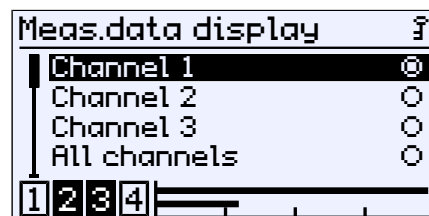

Fig. 135: Measuring data display

In this menu the channel, whose measured value is displayed, is defined. This menu item is not shown for 1-channel devices.

5.4.6.4 Colour change assignment

Path: \Configuration\Display\Col.ch. assignment
 Level: 3

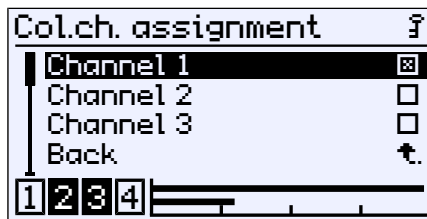

Fig. 136: Colour Change Assignment

This menu is used to set the channel that controls the colour change. This menu item is not displayed for 1 channel devices.

If several channels are selected, the colour change takes place as soon as one of the channels triggers a colour change. The 'triggering' channel is marked with a dot. When re-entering the green area, the indicators are deleted.

Example

Two channels are displayed on the power indicator. First, channel 2 triggers a green-red colour change. A short time later, the same colour change is triggered by channel 1.

Event 1: Colour change green-red on channel 2

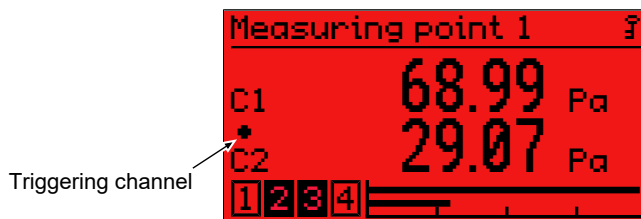

Event 2: Colour change green-red on channel 1

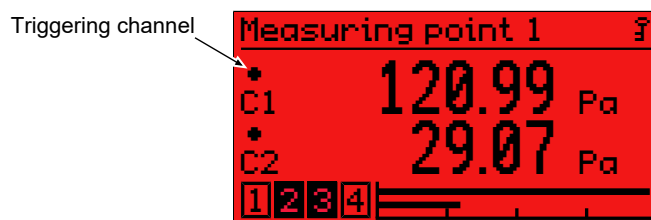

Fig. 137: Measured value display (colour change)

5.4.6.5 LCD colour

Path: \Configuration\Display\LCD colour

Level: 3



Fig. 138: LCD colour

The following colours can be selected for the back lighting.

OFF	
Red	
Green	
Yellow	
Blue	
Magenta	
Cyan	
White	
Red/green	Activation of the colour change red/green
Red/yellow/ green	Activation of the colour change red/yellow/green

The setting for the switch thresholds of the respective colour change are in the menu item Colour change [▶ 71] in the menu for the configuration of the channels.

5.4.6.6 LCD lighting

Path: \Configuration\Display\LCD lighting

Level: 3

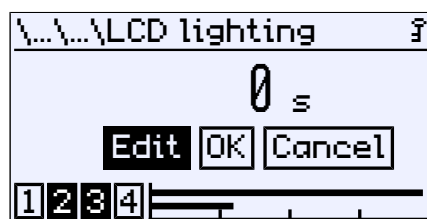

Fig. 139: LCD lighting

This parameter is used to define a time period after which the back lighting is switched off once no more input has been entered via the keyboard. The lighting can be switched on again by pressing any button.

NOTICE! The parameter also impacts in the same way on the colour change. When the lighting is switched off, a colour change is only display when a button is pressed.

Values of 0 to 600 s can be entered. The lighting can be switched on permanently with the parameter value 0s.

5.4.6.7 LCD contrast

Path: \Configuration\Display\LCD contrast
Level: 3



Fig. 140: LCD contrast

This parameter can be used to set the contrast for the LC display.

5.4.7 Modbus RTU

NOTICE! This menu is only available for devices with a Modbus interface.

Path: \Configuration\Modbus RTU

Level: 2

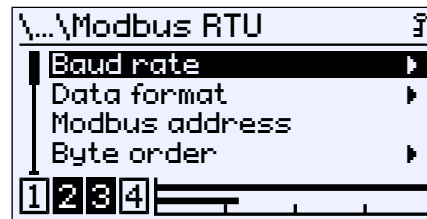

Fig. 141: Modbus RTU

Menu name	Description
Baud rate	The baud rate is set with this menu.
Data format	The data format (data, parity, stop-bit) is defined for the transmission with this menu.
Modbus address	The device address is entered with this parameter.
Byte sequence	The byte order for the floating point figure is defined with this menu.
Back	This represents the output (exit) of the menu. Press 'back' to return to the configuration menu.

5.4.7.1 Baud rate

Path: \Configuration\Modbus RTU\Baud rate
Level: 3

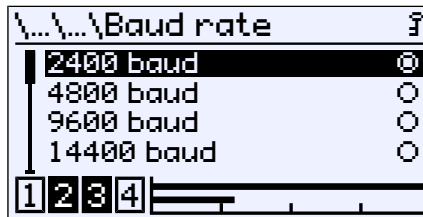

Fig. 142: Baud rate

Baud rates	Description
2400 Baud	Options for data transmission.
4800 Baud	
9600 Baud	
14400 Baud	
19200 Baud	
28800 Baud	
38400 Baud	
56000 Baud	
57600 Baud	
115200 Baud	
Back	⤴. This represents the output (exit) of the menu. Press 'back' to return to the Modbus RTU menu.

5.4.7.2 Data format

Path: \Configuration\Modbus RTU\Data format
Level: 3

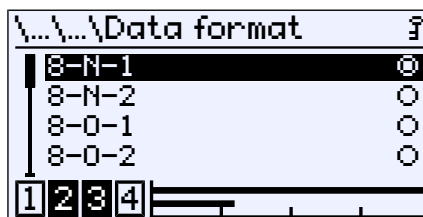

Fig. 143: Data format

Data format	Description
8-N-1	8 data-bit – No parity – 1 stop-bit
8-N-2	8 data-bit – No parity – 2 stop-bit
8-O-1	8 data-bit – Odd parity – 1 stop-bit
8-O-2	8 data-bit – Odd parity – 2 stop-bit
8-E-1	8 data-bit – Even parity – 1 stop-bit
8-E-2	8 data-bit – Even parity – 2 stop-bit
Back	⤴. This represents the output (exit) of the menu. Press 'back' to return to the Modbus RTU menu.

5.4.7.3 Modbus address

Path: \Configuration\Modbus RTU\Modbus address
Level: 3

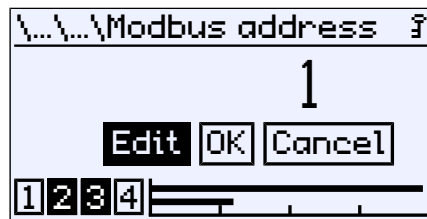

Fig. 144: Modbus address

Addresses from 1 to 247 can be used.

5.4.7.4 Byte order

Path: \Configuration\Modbus RTU\Byte order
Level: 3

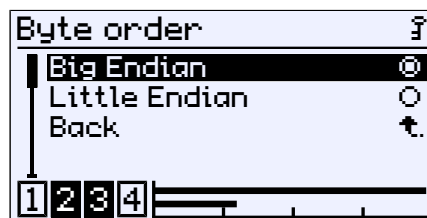

Fig. 145: Byte order

Menu name	Description
Big Endian	The highest value byte first (MSB-LSB).
Little Endian	The lowest value byte first (LSB-MSB).
Back	This represents the output (exit) of the menu. Press 'back' to return to the Modbus RTU menu.

The order for the bytes of the floating point figures is defined with this menu.

5.5 Info

Path: \Info
Level: 1

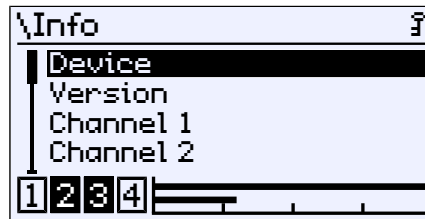

Fig. 146: Info

Various information for configuration and setting of the device is provided in this menu.

Menu name	Description
Dev.	Device type, serial number
Revision	Firmware version
Channel 1	Basic measurement range, spread
Channel 2	Basic measurement range, spread
Analogue output	Output signal
Sw. output	Assignment, contact type
Back	⤴ This represents the output (exit) of the information menu. It takes you back to the main menu.

Information about the device and the configuration are provided in this menu.

5.6 Service

Path: \Service

Level: 1

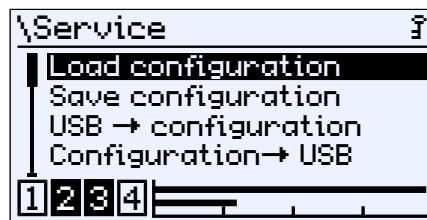

Fig. 147: Service

Menu name	Description
Load configuration	The configuration saved in the flash memory of the device is loaded.
Load configuration	The configuration is saved in the flash memory of the device.
USB → configuration	The configuration saved on a USB drive is loaded.
Configuration → USB	The configuration is saved to a USB drive.
Default configuration	The configuration is reset to the default values. ^{*)}
Firmware update	The firmware update saved on a USB drive is performed.
Back	This is the exit point of the service menu. It takes you "Back" to the main menu.

^{*)} The default values are values that are stored in the flash memory and set the device to a default state. The default configuration is not the same as the customer-specific factory setting. The customer-specific factory setting can only be restored using the inTouch configuration software.

5.6.1 Firmware update

For an update, you will need a USB stick with micro-USB connection or, alternatively, a suitable adapter. The internal USB port is accessible after opening the housing.

Lift the circuit board slightly to insert the stick into the USB connector.



DANGER

Opening the housing on ATEX devices

ATEX devices must never be opened inside potentially explosive areas.

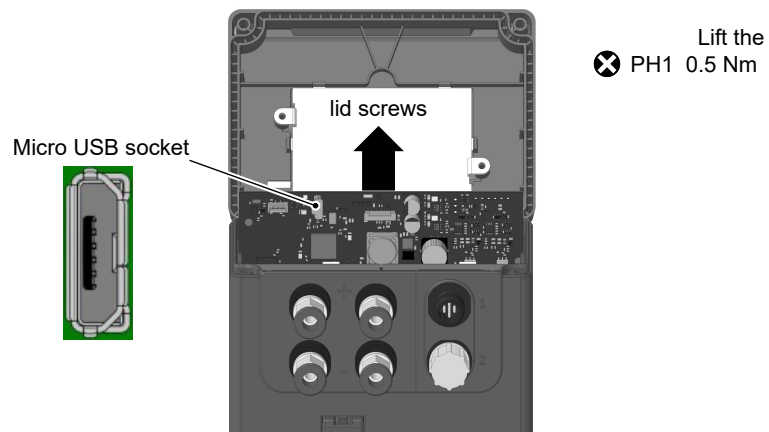

Fig. 148: USB port (example)

If you received the firmware on a FISCHER USB stick, you can immediately start the update. If the update has been supplied as a ZIP archive, unzip the archive to the USB stick's root directory. This creates the right directory structure and you can start the update. If an update is not possible, check whether the "fw" directory exists and the firmware (*.bin) is saved there. Additional files on the stick normally do not disrupt the process and do not need to be deleted.

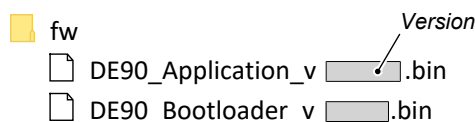

Fig. 149: Example folder structure

▷ Perform the update as follows:

1. Open the housing
2. Insert the USB stick with the new firmware into the USB port.
3. Log in as the user with the right to update firmware.
4. Navigate to the Service menu.
5. Select the Update firmware menu item and start the update. The update takes place automatically.

NOTICE! Sometimes the USB stick is not correctly recognised. In this case, remove the stick and re-insert it during the update.

↪ The new software is now installed. The device restarts once the new firmware has been installed.

6. Remove the USB stick and close the housing.
- ▶ The update is now complete.

6 Servicing

6.1 Maintenance

The instrument is maintenance-free. We recommend the following regular inspection to guarantee reliable operation and a long service life:

- Check the function in combination with downstream components.
- Check the leak-tightness of the pressure connection lines.
- Check the electrical connections.

The exact test cycles need to be adapted to the operating and environmental conditions. In combination with other devices, the operating instructions for the other devices also need to be observed.

6.2 Transport

The measuring device must be protected against impacts. It should be transported in the original packaging or a suitable transport container.

6.3 Service

All defective or faulty devices should be sent directly to our repair department. Please coordinate all shipments with our sales department.



WARNING

Process media residues

Process media residues in and on dismantled devices can be a hazard to people, animals and the environment. Take adequate preventive measures. If required, the devices must be cleaned thoroughly.

Return the device in the original packaging or a suitable transport container.

6.4 Disposal

WEEE-Reg.-No. DE 31751293

Please help to protect our environment and dispose of the workpieces and packaging materials used in an environmentally friendly manner. Observe the country-specific waste treatment and disposal regulations.

The year of production can be found in the production number (serial number):

P# **23** 03618.03.123

Production year 2023 —↑

Further information on disposal can be found on our website
[www.fischermesstechnik.de]



7 Technical data

7.1 General

Type designation	DE91	
Pressure type	Differential pressure	
Measuring principle	Sensor type A	Capacitive
	Sensor type B	Piezoresistiv
Reference conditions (acc. to IEC 61298-1)		
Temperature	+15 to +25 °C	
Relative humidity	45 ... 75 %	
Air pressure	86 to 106 kPa	860 to 1060 mbar
Installation position	vertical	

7.2 Input variables

Measuring variable	Differential pressure for gas-like media	
Conversion	1 Pa	= 10 ⁻⁵ bar
	1 kPa	= 10 ⁻² bar

7.2.1 Sensor type A (capacitive)

This type can be fitted for channel 1 and channel 2.

Measuring range	Max. stat. Operating pressure	Overload	Bursting pressure
0 ... 25 Pa	100 kPa	100 kPa	170 kPa
0 ... 50 Pa			
0 ... 100 Pa			
0 ... 160 Pa			
0 ... 250 Pa			
0 ... 400 Pa			
0 ... 500 Pa			
0 ... 600 Pa			
0 ... 1000 Pa			
-12,5 ... +12,5 Pa			
-25 ... +25 Pa			
-50 ... +50 Pa			
-20 ... +80 Pa			
-100 ... +100 Pa			
-250 ... +250 Pa			
-1 ... +1 kPa			

7.2.2 Sensor type B (piezoresistive)

This type can only be fitted for channel 2.

Measuring range	Max. stat. Operating pressure	Overload	Bursting pressure
0 ... 1600 Pa	31 kPa	31 kPa	41 kPa
0 ... 2500 Pa	31 kPa	31 kPa	41 kPa
0 ... 4000 Pa	31 kPa	31 kPa	41 kPa
0 ... 6000 Pa	80 kPa	80 kPa	100 kPa
0 ... 1,6 kPa	31 kPa	31 kPa	41 kPa
0 ... 2,5 kPa	31 kPa	31 kPa	41 kPa
0 ... 4 kPa	31 kPa	31 kPa	41 kPa
0 ... 6 kPa	80 kPa	80 kPa	100 kPa
0 ... 10 kPa	80 kPa	80 kPa	100 kPa
0 ... 16 kPa	140 kPa	140 kPa	250 kPa
0 ... 25 kPa	140 kPa	140 kPa	250 kPa
-1,6 ... +1,6 kPa	31 kPa	31 kPa	41 kPa
-2,5 ... +2,5 kPa	31 kPa	31 kPa	41 kPa
-4 ... +4 kPa	31 kPa	31 kPa	41 kPa
-6 ... +6 kPa	80 kPa	80 kPa	100 kPa
-10 ... +10 kPa	80 kPa	80 kPa	100 kPa
-16 ... +16 kPa	140 kPa	140 kPa	250 kPa
-25 ... +25 kPa	140 kPa	140 kPa	250 kPa

7.3 Output sizes

Analogausgänge

Die Anzahl der Analogausgänge ist von der Geräteausführung abhängig.

Geräteausführung	1-Kanal	2-Kanal
Anzahl der Analogausgänge	1	2

Das Ausgangssignal ist durch Parametrierung einstellbar. Bei Auslieferung werden beide Analogausgänge auf das gleiche Signal eingestellt (s. Typenschild).

Ausgangssignal	0 ... 20 mA 4 ... 20 mA	0 ... 10 V 2 ... 10 V 1 ... 5 V
Signalbereich	0,0 ... 21,5 mA	0,0 ... 10,5 V
Bürde R_L	$\leq 600 \Omega$	$\geq 2 k\Omega$
Turn down	4:1	4:1

Schaltausgänge

Die Anzahl der Schaltausgänge ist von der Geräteausführung abhängig. Die Zuordnung der Schaltausgänge zu den Kanälen ist frei parametrierbar.

Standardausführung	1-Kanal	2-Kanal
Anzahl der Schaltausgänge	2	4
Zuordnung bei Auslieferung	SP1-> Kanal 1 SP2-> Kanal 1	SP1-> Kanal 1 SP2-> Kanal 1 SP3-> Kanal 2 SP4-> Kanal 2

Modbus (Opt1)	1-Kanal	2-Kanal
Anzahl der Schaltausgänge	0	0
Zuordnung bei Auslieferung	---	--

Modbus (Opt2)	1-Kanal	2-Kanal
Anzahl der Schaltausgänge	4	4
Zuordnung bei Auslieferung	SP1-> Kanal 1 SP2-> Kanal 1 SP3-> Kanal 1 SP4-> Kanal 1	SP1-> Kanal 1 SP2-> Kanal 1 SP3-> Kanal 2 SP4-> Kanal 2

IO-Link	1-Kanal	2-Kanal
Anzahl der Schaltausgänge	4	4
Zuordnung bei Auslieferung	SP1-> Kanal 1 SP2-> Kanal 1 SP3-> Kanal 1 SP4-> Kanal 1	SP1-> Kanal 1 SP2-> Kanal 1 SP3-> Kanal 2 SP4-> Kanal 2

Typ	Potentialfreier Halbleiterschalter (MOS-FET)
progr. Schaltfunktion	Einpoliger Schließer (NO) Einpoliger Öffner (NC)
max. Schaltspannung	3...32 V AC/DC
max. Schaltstrom	0,25 A

max. Schaltleistung	8 W / 8 VA $R_{ON} \leq 4 \Omega$
---------------------	--------------------------------------

7.4 Measuring accuracy

- The specifications for the measurement error incl. linearity and hysteresis.
- All specifications relate to the basic measuring range (see the type plate) and a compensation range of -20 ... +70°C.

7.4.1 Sensor type A (capacitive)

This type can be fitted for channel 1 and channel 2.

Measuring range	Measurement deviation [%]		Zero point [%/10K]		Span [%/10K]	
	Typ.	Max.	Typ.	Max.	Typ.	Max.
0 ... 25 Pa	0,5	1,0	0,3	0,6	0,3	0,6
0 ... 50 Pa						
0 ... 100 Pa						
0 ... 160 Pa						
0 ... 250 Pa						
0 ... 400 Pa						
0 ... 500 Pa						
0 ... 600 Pa						
0 ... 1000 Pa						
-12,5 ... +12,5 Pa						
-25 ... +25 Pa						
-50 ... +50 Pa						
-20 ... +80 Pa						
-100 ... +100 Pa						
-250 ... +250 Pa						
-1 ... +1 kPa						

7.4.2 Sensor type B (piezoresistive)

This type can only be fitted for channel 2.

Measuring range	Measurement deviation [%]		Zero point [%/10K]		Span [%/10K]	
	Typ.	Max.	Typ.	Max.	Typ.	Max.
0 ... 1600 Pa	0,25	0,5	0,15	0,3	0,05	0,1
0 ... 2500 Pa			0,15	0,25		
0 ... 4000 Pa			0,1	0,2		
0 ... 6000 Pa			0,1	0,2		
0 ... 1,6 kPa			0,15	0,3		
0 ... 2,5 kPa			0,15	0,25		
0 ... 4 kPa			0,1	0,2		
0 ... 6 kPa			0,1	0,2		
0 ... 10 kPa			0,1	0,15		
0 ... 16 kPa			0,05	0,1		
0 ... 25 kPa			0,05	0,1		
-1,6 ... +1,6 kPa			0,1	0,2		
-2,5 ... +2,5 kPa			0,1	0,15		
-4 ... +4 kPa			0,05	0,1		
-6 ... +6 kPa			0,05	0,1		
-10 ... +10 kPa			0,05	0,1		
-16 ... +16 kPa			0,05	0,1		
-25 ... +25 kPa			0,05	0,1		

7.5 Digital interfaces

USB interface

USB On The Go	2.0
Data rate	12 Mbit/s (Full Speed)
Connection	Micro USB Type B
Communication	Host/device mode

Modbus RTU interface

Interface	RS 485
Protocol	Modbus RTU
Modbus specification	Application Protocol Specification V1.1b3 (April 26, 2012)
Address	1 ... 247
Baudrate	2400 ... 115200 Baud
Parity	Even, Odd, None
Stop bits	1...2

IO-Link interface

Connection	M12-4 Class A
IO-Link specification	V1.1
Pin assignment	acc. IEC 60974-5-2
Power supply device	max. 200 mA
Data transfer rates	COM 2 = 38,4 kBaud

7.6 Auxiliary energy

NOTICE! Only a CE-compliant mains adapter with a slow 200 mA fuse may be used in the power supply circuit for ATEX devices.

Rated voltage	24 V AC/DC	
Admissible operating voltage U_b	19.2 to 28.8 V AC/DC	Default Modbus RTU
	18 to 30 V DC	IO-Link
Power consumption	Typ. 2W (VA) Max. 3W (VA)	

7.7 Operating conditions

	Standard	ATEX
Umgebungstemperaturbereich	-20 ... +70 °C	-20 ... +60 °C
Mediumtemperaturbereich	-20 ... +70 °C	-20 ... +60 °C
Lagerungstemperaturbereich	-20 ... +70 °C	-20 ... +70 °C
Schutzart	IP65	IP65
EMC	EN 61326-1:2013 EN 61326-2-3:2013	
ATEX	EN IEC 60079-0:2018 EN IEC 60079-7:2015/A1:2018 EN 60079-31:2014	
RoHS	EN IEC 63000:2018	

7.8 Display

Display	Full graphic LC display
Resolution	128 x 64 Pixel
Backlight	RGB
Measured value display	6 digits

7.9 Construction design

Process connection

		Outer Ø	Inner Ø
CK screw connections made of aluminium	Hose	6 mm	4 mm
	Hose	8 mm	6 mm
Pneumatic plug-in connector in nickel-plated brass	Hose	6 mm	4 mm
	Hose	8 mm	6 mm
Cutting ring connection in stainless steel	Pipe	6 mm	
	Pipe	8 mm	

Electrical connection

Standard version	1-channel	2-channel
Connector 1: Auxiliary energy, output	5-pin male	5-pin male
Connector 2: Switch outputs	4-pin male	8-pin male
Modbus without switch outputs	1-channel	2-channel
Connector 1: Modbus IN	5-pin male	5-pin male
Connector 2: Modbus OUT	5-pin female	5-pin female

Modbus with switch outputs	1-channel	2-channel
Connector 1: Modbus	5-pin male	5-pin male
Connector 2: Switch outputs	8-pin male	8-pin male

IO-Link with switch outputs	1-channel	2-channel
Connector 1: IO-Link	4-pin male	4-pin male
Connector 2: Switch outputs	8-pin male	8-pin male

General activities

Installation position	User-defined
Dimensions (without connections)	120 x 81.5 x 95 mm
Weight	Max. 380 g

7.9.1 Materials

Materials of the parts in contact with the medium	
Sensor type A	PBT plastic, rubber, glass, gold, Tygon®, aluminium, titanium and brass
Sensor type B	Silicon, PVC, FKM, aluminium, brass, stainless steel, PP/EPDM

Materials of the parts in contact with the environment
Polyester, PET, polyamide 6.6, aluminium, nickel-plated brass, stainless steel

7.9.2 Dimensional drawings

All dimensions in mm unless otherwise stated

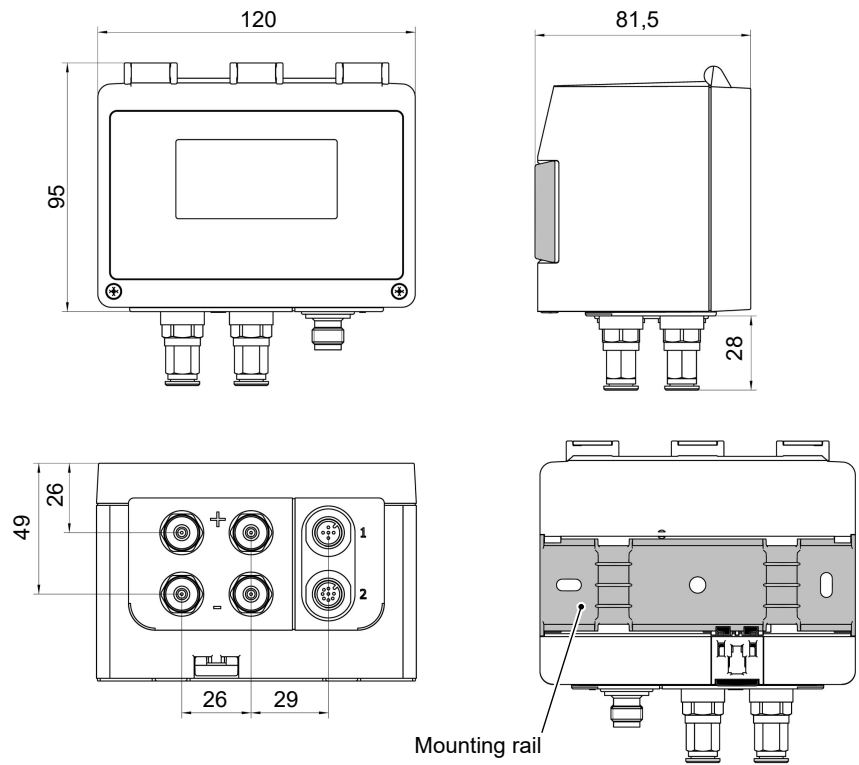

Fig. 150: Dimension drawing

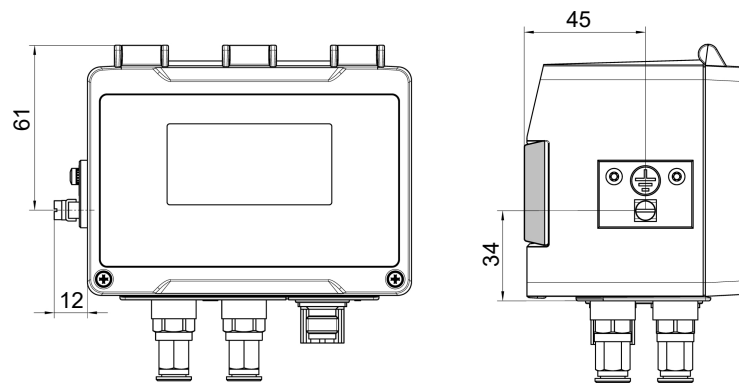

Fig. 151: Dimension drawing ATEX

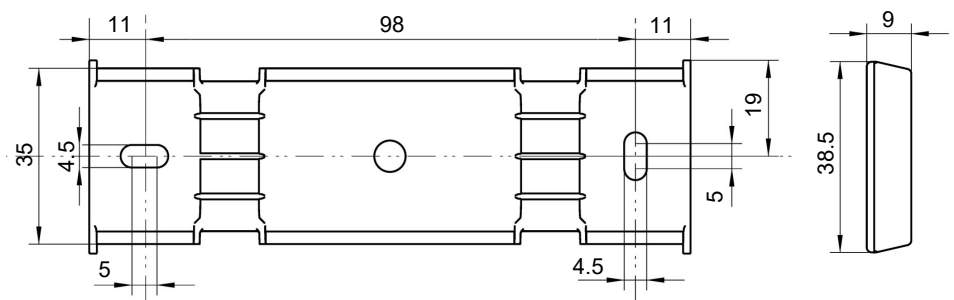

Fig. 152: Mounting rail

Process connections

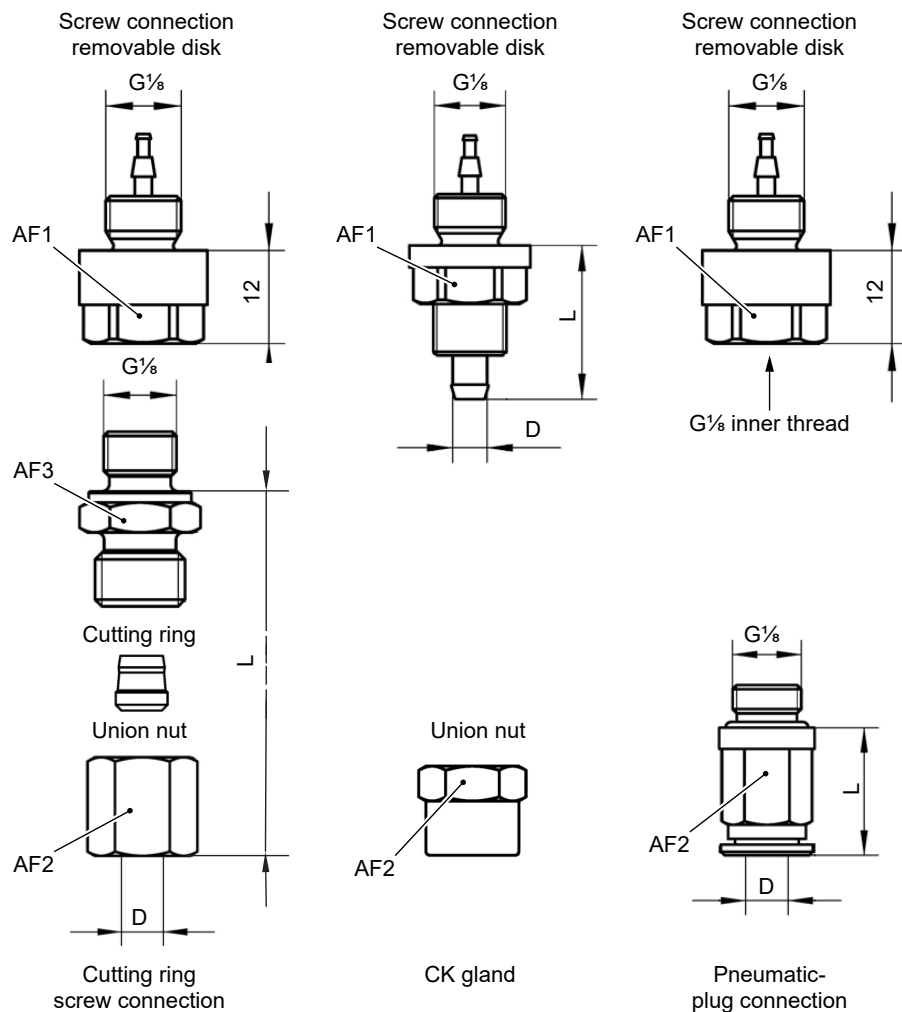
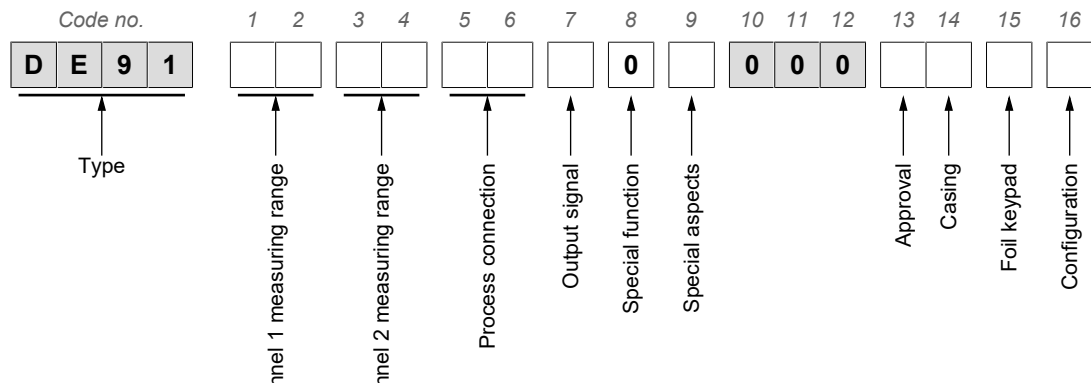

Fig. 153: Process connection Options

Prozessanschluss		D	d	L	AF1	AF2	AF3
Cutting ring screw connection	Pipe	6	---	23.5	14	14	14
		8	---	24.5	14	17	14
CK gland	Hose	6	4	21	14	12	---
		8	6	21	14	14	---
Pneumatic plug connection	Pneumatic hose	6	4	18	14	11	---
		8	6	20.5	14	13	---

D: outside diameter; d: inside diameter

8 Order codes



[1,2] Measuring ranges channel 1		
<i>Sensor type A (capacitive)</i>		
D1	0 ...	25 Pa
J6	0 ...	50 Pa
D4	0 ...	100 Pa
D5	0 ...	160 Pa
D6	0 ...	250 Pa
D7	0 ...	400 Pa
J7	0 ...	500 Pa
D8	0 ...	600 Pa
D9	0 ...	1000 Pa
L4	-12.5 ...	+12.5 Pa
L5	-25 ...	+25 Pa
L2	-50 ...	+50 Pa
L0	-20 ...	+80 Pa
L7	-100 ..	+100 Pa
L6	-250 ...	+250 Pa
L8	-1 ...	+1 kPa

[3,4] Measuring ranges channel 2		
00	ohne	
<i>Sensor type A (capacitive)</i>		
D1	0 ...	25 Pa
J6	0 ...	50 Pa
D4	0 ...	100 Pa
D5	0 ...	160 Pa
D6	0 ...	250 Pa
D7	0 ...	400 Pa
J7	0 ...	500 Pa
D8	0 ...	600 Pa
D9	0 ...	1000 Pa
L4	-12.5 ...	+12.5 Pa
L5	-25 ...	+25 Pa
L2	-50 ...	+50 Pa
L0	-20 ...	+80 Pa
L7	-100 ..	+100 Pa

[3,4] Measuring ranges channel 2		
L6	-250 ...	+250 Pa
L8	-1 ...	+1 kPa
<i>Sensor type B (piezoresistive)</i>		
E1	0 ...	1600 Pa
E2	0 ...	2500 Pa
E3	0 ...	4000 Pa
E4	0 ...	6000 Pa
N2	0 ...	1.6 kPa
N3	0 ...	2.5 kPa
N4	0 ...	4 kPa
N5	0 ...	6 kPa
E5	0 ...	10 kPa
E6	0 ...	16 kPa
E7	0 ...	25 kPa
L9	-1.6 ...	+1.6 kPa
M6	-2.5 ...	+2.5 kPa
M7	-4 ...	+4 kPa
M8	-6 ...	+6 kPa
R8	-10 ...	+10 kPa
R9	-16 ...	+16 kPa
T1	-25 ...	+25 kPa

[5,6] Process connection	
00	G $\frac{1}{8}$ Internal thread (aluminium)
40	CK screw connection made of aluminium for 6/4 mm hose
41	CK screw connection made of aluminium for 8/6 mm hose
P6	Pneumatic push-in connector MS nickel-plated for 6/4 mm hose
P8	Pneumatic push-in connector MS nickel-plated for 8/6 mm hose
24	Stainless steel cutting ring fitting for 6 mm pipe
25	Stainless steel cutting ring fitting for 8 mm pipe

[7] Output signal	
0	ohne
<i>Switchable, factory preset:</i>	
C	0 ... 10 V
A	0 ... 20 mA
P	4 ... 20 mA
<i>Digital interface:</i>	
M	RS485 Modbus RTU (without switching outputs)
N	RS485 Modbus RTU (with 4 switching outputs)
I	IO-Link (with 4 switching outputs)

[8] Special function	
0	without

[9] Special features	
0	ohne
E	Measuring accuracy $\pm 0.5\%$

[13,14]	Authorisation	Housing	Lid colour
00	without	Anthrazite	Green
R1	ATEX Zone 2 and 22	Black (conductive)	Black (conductive)

[15] Membrane keypad	
0	Fischer
1	neutral

[16] Parameterisation	
0	Standard
1	Linear characteristic curve
2	Flow rate
3	Table
4	Volume flow with K-factor
5	Formula
6	Dynamic filter monitoring
7	Difference
Z	customised

8.1 Accessories

M12 connection cables

Designation	No. of pins	Length	Order No.
PUR connection cable with M12 connector	4 pins	2 m	06401993
		5 m	06401994
		10 m	06401572
	5-pin	2 m	06401995
		5 m	06401996
		10 m	06401573
	8-pin	2 m	09001844
		5 m	09011146
		10 m	09011016

USB interface

Designation		Order No.
Connection cable, USB-A on USB micro-B connector	2 m	09007340
Stick USB 2.0, USB-A/micro-B connector	16 GB	09007316

Modbus

Designation		Order No.
Modbus terminating resistor	120 ohm socket	06411280
	120 ohm connector	06411279

Connection set

To connect the differential pressure transmitter to the ventilation channels comprising

- 2 x PVC hose
- 2 x ABS weld socket incl. attachment screws.

Designation	Hose	Length	Order No.
Plastic connection set	2 x 6/4 mm	1 m	04005129
		2.5 m	04005148
		5 m	04005163
		10 m	04005216
	2 x 8/6 mm	1 m	04005217
		5 m	04005218

Comments:

For 2-channel devices, two connection sets may be required in some circumstances.

Complete connection set

To connect the differential pressure transmitter to the ventilation channels comprising

- 2 x PVC hose
- 2 x ABS weld socket incl. attachment screws
- 2 x field-wireable M12 connector
 - Channel 1: 4-pin/5-pin socket
 - Channel 2: 8-pin/5-pin socket

Designation	Hose	Length	Order No.	
Complete connection set	1-channel	4/6 mm	1 m	06411560
		6/8 mm	1 m	06411561
	2 channels	4/6 mm	1 m	06411562
		6/8 mm	1 m	06411563

Recalibration connection set

To ensure correct measurements at all times, it is necessary to calibrate the pressure transducer regularly and bring it back in line with national or international standards.

Designation	Order No.
Recalibration connection set	06411887
2x Push-in T-fitting, male thread G1/8 Female thread G1/8 - for hose, outer Ø 6 mm	
2x Plug-in sleeve Ø 6 mm	
2x Ball valve QH-QS-6-1/8	

Software

The configuration software inTouch is available at fischermesstechnik.de as a download.

9 Attachments

9.1 EU Declaration of Conformity



(Translation)

EU Declaration of Conformity

For the product described as follows

Product designation **Differential Pressure Transmitter**
Type designation **DE91**

it is hereby declared that it corresponds with the basic requirements specified in the following designated directives:

2014/30/EU	EMC Directive
2011/65/EU	RoHS Directive
(EU) 2015/863	Delegated Directive amending Annex II to Directive 2011/65/EU

The products were tested in compliance with the following standards.

Electromagnetic compatibility (EMC)

<i>DIN EN IEC 61326-1:2022-11</i>	<i>Electrical equipment for measurement, control and laboratory use - EMC requirements - Part 1: General requirement</i>
<i>EN IEC 61326-1:2021</i>	
<i>DIN EN IEC 61326-2-3:2022-11</i>	<i>Electrical equipment for measurement, control and laboratory use - EMC requirements - Part 2-3: Particular requirements - Test configuration, operational conditions and performance criteria for transducers with integrated or remote signal conditioning</i>
<i>EN IEC 61326-2-3:2021</i>	

RoHS Directive (RoHS 3)

<i>DIN EN IEC 63000:2019-05</i>	<i>Technical documentation for the assessment of electrical and electronic products with respect to the restriction of hazardous substances</i>
<i>EN IEC 63000:2018</i>	

Also they were subjected to the conformity assessment procedure „Internal production control“.

Sole responsibility for the issue of this declaration of conformity in relation to fulfilment of the fundamental requirements and the production of the technical documents is with the manufacturer.

Manufacturer **FISCHER Mess- und Regeltechnik GmbH**
 Bielefelder Str. 37a
 32107 Bad Salzufflen, Germany
 Tel. +49 (0)5222 974 0

Documentation representative Torsten Malischewski
 General Manager R&D

The devices bear the following marking:

Bad Salzufflen
 12 April 2024

T. Malischewski
 General Manager R&D

09010883 • CE_EN_DE91 • Rev. ST4-A • 04/24



1 / 1

Fig. 154: CE_DE_DE91



(Translation)

EU Declaration of Conformity

For the product described as follows

Product designation Differential Pressure Transmitter
Type designation DE91 ## ## ## # # # 000 R1 # #

it is hereby declared that it corresponds with the basic requirements specified in the following designated directives:

2014/30/EU	EMC Directive
2014/34/EU	ATEX Directive
2011/65/EU	RoHS Directive
(EU) 2015/863	Delegated Directive amending Annex II to Directive 2011/65/EU

The products were tested in compliance with the following standards.

Electromagnetic compatibility (EMC)

DIN EN IEC 61326-1:2022-11 EN IEC 61326-1:2021	Electrical equipment for measurement, control and laboratory use - EMC requirements - Part 1: General requirement
DIN EN IEC 61326-2-3:2022-11 EN IEC 61326-2-3:2021	Electrical equipment for measurement, control and laboratory use - EMC requirements - Part 2-3: Particular requirements - Test configuration, operational conditions and performance criteria for transducers with integrated or remote signal conditioning

Explosive atmospheres (ATEX)

DIN EN IEC 60079-0:2019-09 EN IEC 60079-0:2018 Correction1 IEC 60079-0:2017/COR1:2020	Explosive atmospheres - Part 0: Equipment - General requirements
DIN EN IEC 60079-7/A1:2018-07 EN IEC 60079-7:2015/A1:2018	Explosive atmospheres - Part 7: Equipment protection by increased safety "e" (IEC 60079-7:2015/A1:2017)
DIN EN 60079-31:2014-12 EN 60079-31:2014	Explosive atmospheres - Part 31: Equipment dust ignition protection by enclosure "t"

RoHS Directive (RoHS 3)

DIN EN IEC 63000:2019-05 EN IEC 63000:2018	Technical documentation for the assessment of electrical and electronic products with respect to the restriction of hazardous substances
--	--

Also they were subjected to the conformity assessment procedure „Internal production control“.

Sole responsibility for the issue of this declaration of conformity in relation to fulfilment of the fundamental requirements and the production of the technical documents is with the manufacturer.

Manufacturer FISCHER Mess- und Regeltechnik GmbH
 Bielefelder Str. 37a
 32107 Bad Salzuflen, Germany
 Tel. +49 (0)5222 974 0

Documentation representative Torsten Malischewski
 General Manager R&D

The devices bear the following marking:

Bad Salzuflen
12 April 2024
 T. Malischewski
 General Manager R&D

09010895 • CE_EN_DE91_ATEX • Rev. ST4-A • 04/24

1 / 1



Fig. 155: CE_DE_DE91_ATEX

9.2 UKCA declaration of conformity



UKCA Declaration of Conformity

For the product described as follows

Product designation Differential pressure transmitter
Type designation DE91 ## ## ## # 0 0 000 ## # #

is hereby declared to comply with the essential requirements, specified in the following UK regulations:

<i>Statutory regulation No.</i>	<i>Description</i>
2016 No. 1091	The Electromagnetic Compatibility Regulations 2016
2021 No. 422	The Restriction of the Use of Certain Hazardous Substances in Electrical and Electronic Equipment (Amendment) Regulations 2021
2022 No. 1647	The Hazardous Substances and Packaging (Legislative Functions and Amendment) (EU Exit) Regulations 2020

The products have been tested according to the following standards.

Electromagnetic compatibility (EMC):

BS EN IEC 61326-1:2021-06-07	Electrical equipment for measurement, control and laboratory use. EMC requirements. General requirements
BS EN IEC 61326-2-3:2021-06-10	Electrical equipment for measurement, control and laboratory use. EMC requirements. Particular requirements. Test configuration, operational conditions and performance criteria for transducers with integrated or remote signal conditioning

Restriction of Hazardous Substances (RoHS):

BS EN IEC 63000:2018-12-10	Technical documentation for the assessment of electrical and electronic products with respect to the restriction of hazardous substances
----------------------------	--

The sole responsibility for drawing up this declaration of conformity in relation to the fulfilment of the essential requirements and the preparation of the technical documentation lies with the manufacturer.

Manufacturer FISCHER Mess- und Regeltechnik GmbH
 Bielefelder Str. 37a
 32107 Bad Salzufflen, Germany
 Tel. +49 (0)5222 974 0

The devices bear the following marking:

Bad Salzufflen
 12 April 2024

T. Malischewski
 General Manager R&D



Fig. 156: UKCA_DE_DE91

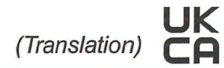

UKCA Declaration of Conformity

For the product described as follows

Product designation Differential pressure transmitter
Type designation DE91 ## ## ## # # # 000 R1 # #

is hereby declared to comply with the essential requirements, specified in the following UK regulations:

<i>Statutory regulation No.</i>	<i>Description</i>
2016 No. 1107	The Equipment and Protective Systems Intended for Use in Potentially Explosive Atmospheres Regulations 2016
2016 No. 1101	The Electrical Equipment (Safety) Regulations 2016
2016 No. 1091	The Electromagnetic Compatibility Regulations 2016
2021 No. 422	The Restriction of the Use of Certain Hazardous Substances in Electrical and Electronic Equipment (Amendment) Regulations 2021
2022 No. 1647	The Hazardous Substances and Packaging (Legislative Functions and Amendment) (EU Exit) Regulations 2020

The products have been tested according to the following standards.

Explosive atmospheres (ATEX):

BS EN IEC 60079-0:2018-07-09	Explosive atmospheres. Equipment. General requirements
BS EN IEC 60079-7+A1:2015-12-31	Explosive atmospheres. Equipment protection by increased safety "e"
BS EN 60079-31:2014-07-31	Explosive atmospheres. Equipment dust ignition protection by enclosure "t"

Electromagnetic compatibility (EMC):

BS EN IEC 61326-1:2021-06-07	Electrical equipment for measurement, control and laboratory use. EMC requirements. General requirements
BS EN IEC 61326-2-3:2021-06-10	Electrical equipment for measurement, control and laboratory use. EMC requirements. Particular requirements. Test configuration, operational conditions and performance criteria for transducers with integrated or remote signal conditioning

Restriction of Hazardous Substances (RoHS):

BS EN IEC 63000:2018-12-10	Technical documentation for the assessment of electrical and electronic products with respect to the restriction of hazardous substances
----------------------------	--

The sole responsibility for drawing up this declaration of conformity in relation to the fulfilment of the essential requirements and the preparation of the technical documentation lies with the manufacturer.

Manufacturer FISCHER Mess- und Regeltechnik GmbH
Bielefelder Str. 37a
32107 Bad Salzuflen, Germany
Tel. +49 (0)5222 974 0

The devices bear the following marking: UK CA II 3G Ex ec IIC T4 Gc
II 3D Ex tc IIIB T125°C Dc

ppa. T. Malischewski

Bad Salzuflen
12 April 2024
T. Malischewski
General Manager R&D



Fig. 157: UKCA_DE_DE91_ATEX

9.3 EAC Declaration of conformity

ЕВРАЗИЙСКИЙ ЭКОНОМИЧЕСКИЙ СОЮЗ ДЕКЛАРАЦИЯ О СООТВЕТСТВИИ



Заявитель Общество с ограниченной ответственностью "МАТИС-М"

Место нахождения: Россия, Москва, 117261, улица Вавилова, дом 70, строение 3, Комната Правления, адрес места осуществления деятельности: Россия, Москва, 109029, Сибирский проезд, дом 2, строение 9, офис 58, основной государственный регистрационный номер: 1037739575125, номер телефона: +74957252304, адрес электронной почты: info@matis-m.ru

в лице Генерального директора Шарова Александра Анатольевича

заявляет, что Датчики дифференциального давления серии DE

изготовитель "FISCHER Mess- und Regeltechnik GmbH". Место нахождения и адрес места осуществления деятельности по изготовлению продукции: Bielefelder Straße 37a, D-32107 Bad Salzuflen, GLN отсутствует, координаты ГЛОНАСС: 52.056894, 8.725524, Германия.

Продукция изготовлена в соответствии с Директивой 2014/35/EU.

Код ТН ВЭД ЕАЭС 9026202000. Серийный выпуск

соответствует требованиям

Технического регламента Таможенного союза "О безопасности низковольтного оборудования" (ТР ТС 004/2011), Технического регламента Таможенного союза "Электромагнитная совместимость технических средств" (ТР ТС 020/2011)

Декларация о соответствии принята на основании

Протоколов испытаний № 0105-ИЛ23/2022, 0105-ИЛ23/2022 от 31.01.2022 года, выданных Испытательной лабораторией Общества с ограниченной ответственностью «ПромМашЭксперт», аттестат аккредитации РОСС RU.32001.04ИБФ1.ИЛ23, сроком действия до 02.02.2022 года.

Схема декларирования 1д

Дополнительная информация

Условия и сроки хранения стандартные при нормальных значениях климатических факторов внешней среды, срок службы (годности) указан в эксплуатационной документации. Договор на выполнение функций иностранного изготовителя № 2016-09-29/01 от 29.09.2016.

Декларация о соответствии действительна с даты регистрации по 31.01.2027 включительно

(подпись)

М. П.

Шаров Александр Анатольевич

(Ф.И.О. заявителя)

Регистрационный номер декларации о соответствии: ЕАЭС N RU Д-DE.PA01.B.52516/22

Дата регистрации декларации о соответствии: 01.02.2022

Fig. 158: Декларация DE_ЕАЭС N RU Д-DE.PA01.B.52516_22 (002)

Notes

Notes

Notes



FISCHER Mess- und Regeltechnik GmbH

Bielefelder Str. 37a
D-32107 Bad Salzuflen

Tel. +49 5222 974-0

Fax +49 5222 7170

www.fischermesstechnik.de

info@fischermesstechnik.de